

Low Voltage General Purpose Motors

Cast iron motor section



Making you more competitive

ABB's General purpose motor is designed for use in general industry, meeting the demands of standard applications for OEM's. Motors are readily available from central stock locations and distributors around the world. The motors have high build quality, are available with all the features needed by the OEM market and can be modified to meet most specifications.



ABB (www.abb.com) is a leader in power and automation technologies that enable utility and industry customers to improve performance while lowering environmental impacts. The ABB Group of companies operates in around 100 countries and employs around 103,000 people.

Low Voltage General Purpose Motors

Sizes 56 to 400, from 0.055 to 630 kW

	Contents	Page	
1	General information	4	1
2	Aluminum motors	11	2
3	Steel motors	81	3
4	Cast iron motors	113	4
5	Open drip proof motors	147	5
6	Global motors	167	6
7	Brake motors	193	7
8	Single phase motors	219	8
9	Integral motors	237	9

ABB reserves the right to change the design, technical specification and dimensions without prior notice.

This pdf includes section 4, see complete pdf for other sections.

General information

Standards

ABB motors are of the totally enclosed and open drip proof, single or three phase squirrel cage type, built to comply with international IEC and EN standards. Motors conforming to other national and international specifications are also available on request.

All production units are certified to ISO 9001 international quality standard as well ISO 14000 environmental standard and confirm to all applicable EU Directives.

IEC / EN

Electrical	Mechanical
IEC/EN 60034-1	IEC 60072
IEC/EN 60034-2	IEC/EN 60034-5
IEC 60034-8	IEC/EN 60034-6
IEC 60034-12	IEC/EN 60034-7
	IEC/EN 60034-9
	IEC 60034-14

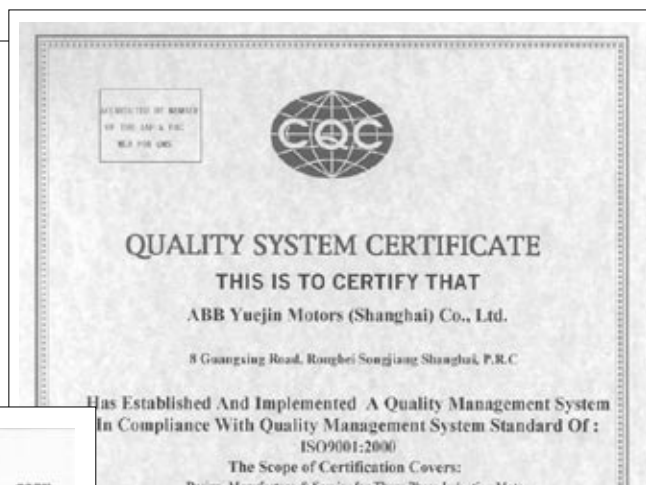

Motors for EU motor efficiency levels

A Europe-wide agreement will ensure that the efficiency levels of electric motors manufactured in Europe are clearly displayed. In contrast to the American legislation on motor efficiency the European agreement does not establish mandatory efficiency levels.

It basically establishes three classes giving motor manufacturers an incentive to qualify for a higher class.

ABB is one of only a handful of leading motor manufacturers in Europe to have a motor range to meet or exceed the minimum efficiencies stated in the highest level of the EU agreement of LV motors.

These efficiency levels apply to 2- and 4-pole, three phase squirrel cage induction motors rated for 400V, 50Hz with S1 duty class with the output 1.1 to 90 kW, which

account for the largest volume on the market.

The efficiency of motors from different manufacturers are collated in a database, EURODEEM, published by the European Commission. It is accessible over the Internet at <http://iamest.jrc.it/projects/eem/eurodeem.htm>.



EU efficiency classes for 2-pole motors

Output kW	2-pole Boarderline	
	EFF2/EFF3	EFF1/EFF2
1.1	76.2	82.8
1.5	78.5	84.1
2.2	81.0	85.6
3	82.6	86.7
4	84.2	87.6
5.5	85.7	88.6
7.5	87.0	89.5
11	88.4	90.5
15	89.4	91.3
18.5	90.0	91.8
22	90.5	92.2
30	91.4	92.9
37	92.0	93.3
45	92.5	93.7
55	93.0	94.0
75	93.6	94.6
90	93.9	95.0

ABB Three phase induction motors, 400 V 50 Hz - EU motor efficiency levels

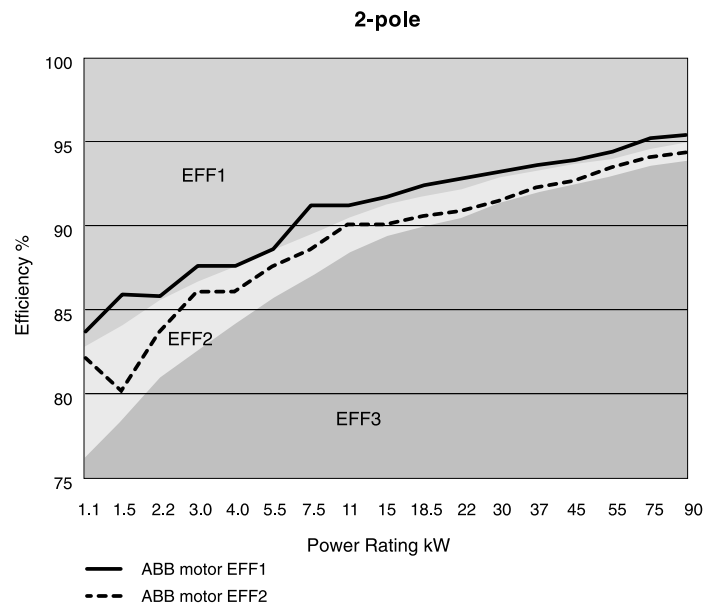

EU efficiency classes for 4-pole motors

Output kW	4-pole Boarderline	
	EFF2/EFF3	EFF1/EFF2
1.1	76.2	83.8
1.5	78.5	85.0
2.2	81.0	86.4
3	82.6	87.4
4	84.2	88.3
5.5	85.7	89.2
7.5	87.0	90.1
11	88.4	91.0
15	89.4	91.8
18.5	90.0	92.2
22	90.5	92.6
30	91.4	93.2
37	92.0	93.6
45	92.5	93.9
55	93.0	94.2
75	93.6	94.7
90	93.9	95.0

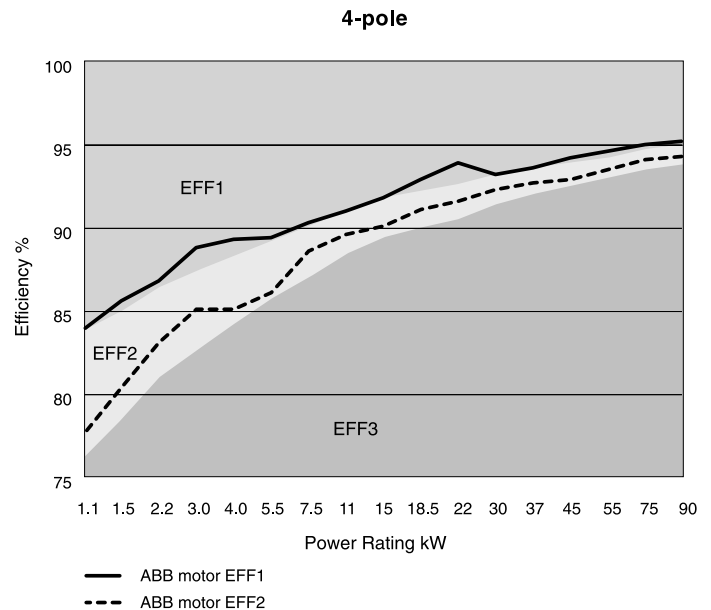

General technical specification

Mechanical and electrical design

Mounting arrangements

1

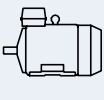
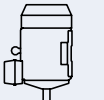
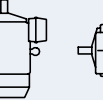
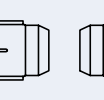
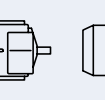
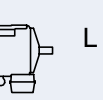
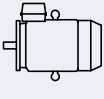
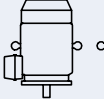
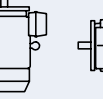
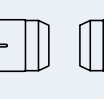
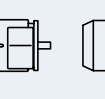
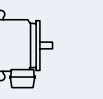
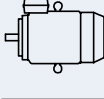
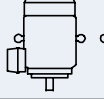
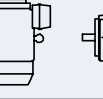
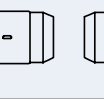
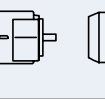
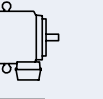
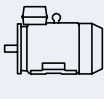
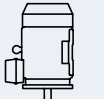
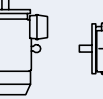
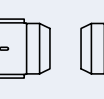
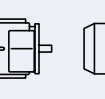
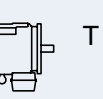
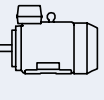
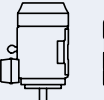
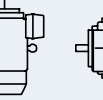
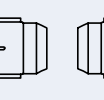
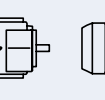
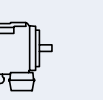
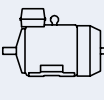
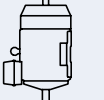
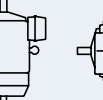
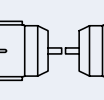
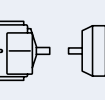
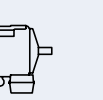
	Codell/Codell						Product code pos. 12
Foot-mounted motor.	IM B3 IM 1001	IM V5 IM 1011	IM V6 IM 1031	IM B6 IM 1051	IM B7 IM 1061	IM B8 IM 1071	A = foot-mounted, term.box top R = foot-mounted, term.box RHS L = foot-mounted, term.box LHS
							
Flange-mounted motor, large flange	IM B5 IM 3001	IM V1 IM 3011	IM V3 IM 3031	*) IM 3051	*) IM 3061	*) IM 3071	B = flange mounted, large flange
							
Flange-mounted motor, small flange	IM B14 IM 3601	IM V18 IM 3611	IM V19 IM 3631	*) IM 3651	*) IM 3661	*) IM 3671	C = flange mounted, small flange
							
Foot- and flange-mounted motor with feet, large flange	IM B35 IM 2001	IM V15 IM 2011	IM V36 IM 2031	*) IM 2051	*) IM 2061	*) IM 2071	H = foot/flange-mounted, term.box top S = foot/flange-mounted, term.box RHS T = foot/flange-mounted, term.box LHS
							
Foot- and flange-mounted motor with feet, small flange	IM B34 IM 2101	IM V17 IM 2111	IM 2131	IM 2151	IM 2161	IM 2171	J = foot/flange-mounted, small flange
							
Foot-mounted motor, shaft with free extensions	IM 1002	IM 1012	IM 1032	IM 1052	IM 1062	IM 1072	
							
*) Not stated in IEC 60034-7.							

Cooling

Designation system concerning methods of cooling refers to standard IEC 60034-6.

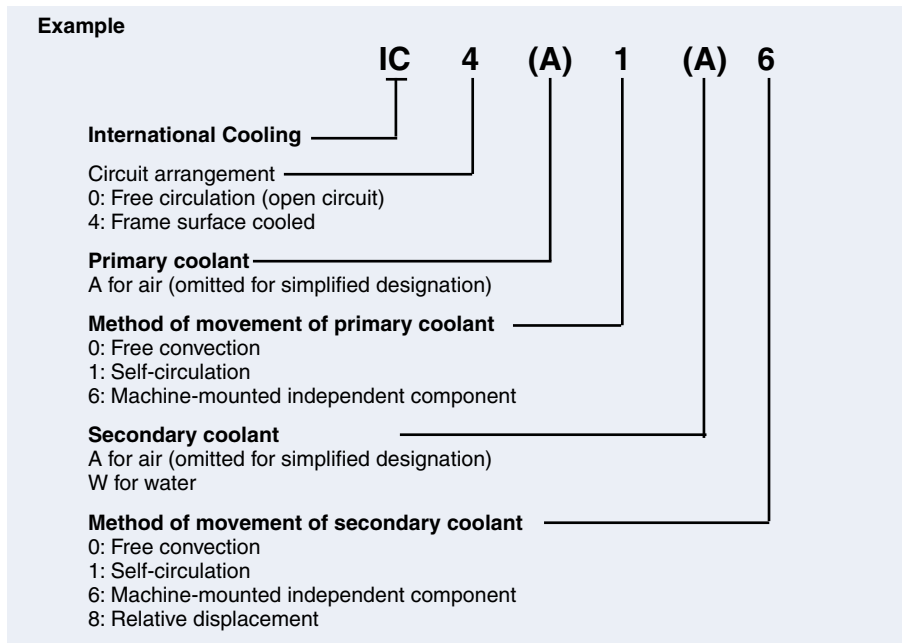

Degrees of protection: IP code/IK code

Classification of degrees of protection provided by enclosures of rotating machines are refers to:

- Standard IEC 60034-5 or EN 60529 for IP code
- Standard EN 50102 for IK code

IP protection:

Protection of persons against getting in contact with (or approaching) live parts and against contact with moving parts inside the enclosure. Also

protection of the machine against ingress of solid foreign objects. Protection of machines against the harmful effects due to the ingress of water

IK code :

Classification of degrees of protection provided by enclosure for motors against external mechanical impacts.

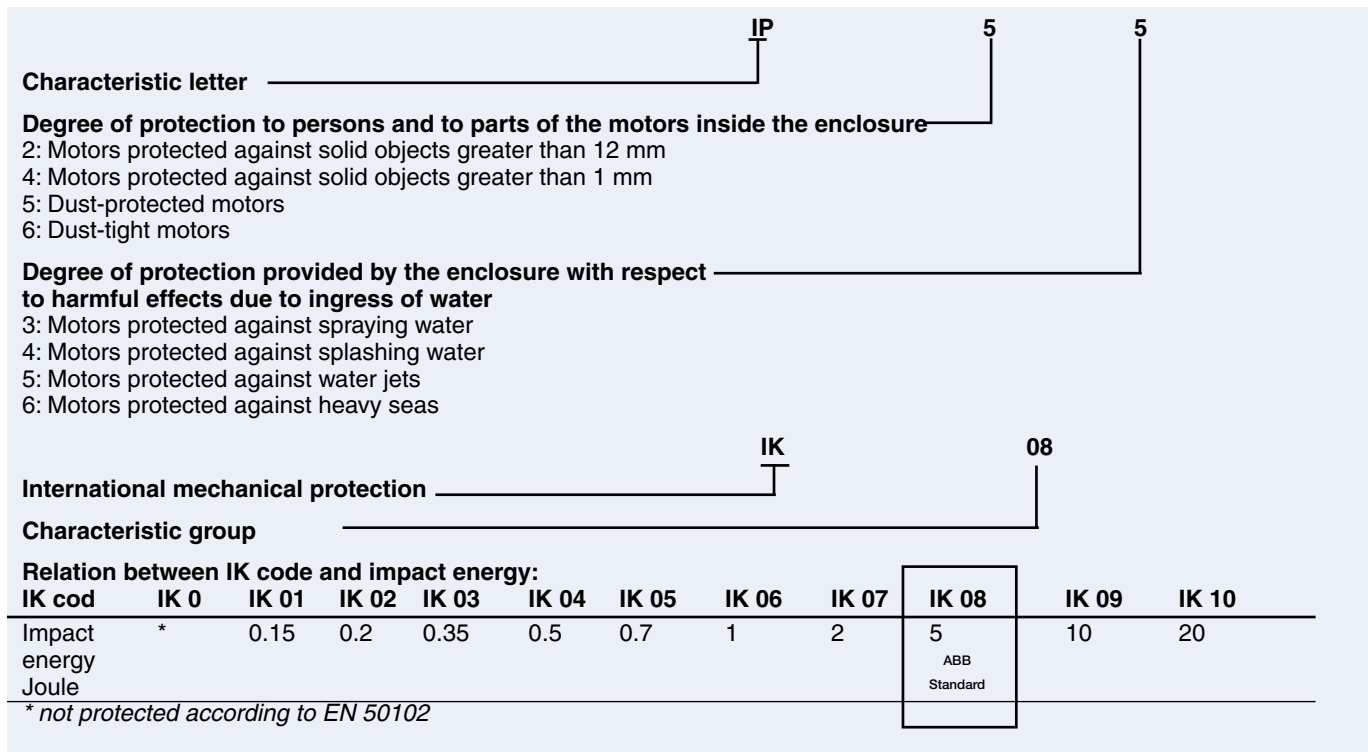

Insulation

ABB uses class F insulation systems, which, with temperature rise B, is the most common requirement among industry today.

The use of Class F insulation with Class B temperature rise gives ABB products a 25° C safety margin. This can be used to increase the loading for limited periods, to operate at higher ambient temperatures or altitudes, or with greater voltage and frequency tolerances. It can also be used to extend insulation life. For instance, a 10 K temperature reduction will extend the insulation life.

Class F insulation system

- Max ambient temperature 40° C
- Max permissible temperature rise 105 K
- Hotspot temperature margin + 10 K

Class B rise

- Max ambient temperature 40° C
- Max permissible temperature rise 80 K
- Hotspot temperature margin + 10 K

Insulation system temperature class

- Class F 155° C
- Class B 130° C
- Class H 180° C

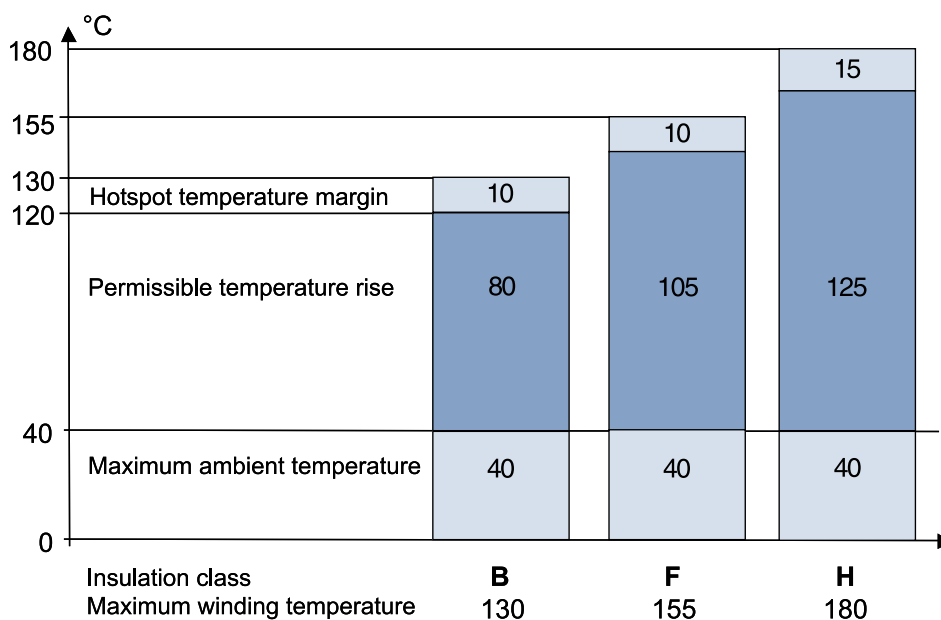

Safety margins per insulation class

Frequency converter drives

Squirrel cage induction motors offer excellent availability, reliability and efficiency. With a frequency converter – a variable speed drive (VSD) – the motor will deliver even better value. A variable speed drive motor can be started softly with low starting current, and the speed can be controlled and adjusted to suit the application demand without steps over a wide range. Also the use of a frequency converter together with a squirrel cage motor usually leads to remarkable energy and environmental savings.

However, all motors are not suitable for variable speed drive. There are several points that have to be taken into account in the design and selection of the motor, if it is intended for variable speed operation.

Within the General purpose motor range ABB offers motors designed for both Direct On Line (DOL) and variable speed applications.

For more demanding applications the use of ABB Process performance motors is recommended.

The following points must be taken into account, when selecting a motor to a variable speed drive:

1. Dimensioning

The voltage (or current) fed by the frequency converter is not purely sinusoidal. This may increase the losses, vibration, and noise of the motor. Furthermore, a change in the distribution of the losses may affect to the temperature rise of the motor. In each case, the motor must be correctly sized according to the instructions supplied with the selected frequency converter.

When using ABB converters, please use ABB's DriveSize dimensioning programme or the loadability curves of the corresponding converter type for sizing the motors. The loadability curve for applicable General purpose motors used with ABB's ACS 600- and ACS 800- frequency converters can be found in figure 3.

2. Speed range

In a frequency converter drive, the actual operating speed of the motor may deviate considerably from its nominal speed (i.e. the speed stamped on the rating plate).

For higher speeds, ensure that the highest permissible rotational speed of the motor or the critical speed of the entire equipment is not exceeded. When high speed operation exceeds the nominal speed of the motor, the following points should be checked:

- Maximum torque of the motor
- Bearing construction
- Lubrication
- Balancing
- Critical speeds
- Shaft seals
- Ventilation
- Fan noise

Guideline values of maximum speeds for M3AA motors within the General purpose motor range are described in figure 1 below. Exact values are available on request.

Figure 1. Guideline values of maximum speeds for General purpose motor in aluminium frame:

Motor size	Speed r/min	
	2-pole	4-pole
M3AA 90-100	6000	6000
M3AA 112-200	4500	4500
M3AA 225-280	3600	3600

At low speed operation the motor's ventilation fan loses its cooling capacity, which causes a higher temperature rise in the motor and in the bearings. A separate constant speed fan can be used to increase cooling capacity and loadability at low speed. It is also important to check the performance of the grease at low speeds.

3. Lubrication

Variable speed operation affects on the bearing temperature, which must be taken into account when selecting the lubrication method and grease type. For example the life time of sealed bearings can be remarkably shorter than in direct on line operation. More information can be found from product specific sections of this catalogue and from ABB's Low Voltage Motors Manual.

4. Insulation protection

Frequency converter supply causes higher voltage stresses at the windings of the motor than the sinusoidal supply. Thus, the insulation system and possible filters must be selected according to the used voltage, cable length and converter type.

When using ABB's low voltage frequency converters, selection criterias mentioned in figure 2 must be followed.

5. Bearing currents

Bearing voltages and currents must be avoided in all motors. Assuming the use of ABB ACS 800 or ACS 550 drive, with uncontrolled DC-voltage, insulated bearings and/or properly dimensioned filters at the converter output must be used according to the instructions in figure 2. (For other alternatives and converter types, please contact ABB.) When ordering, clearly state which alternative will be used.

For more information about bearing currents and voltages, please contact ABB.

6. Cabling, grounding and EMC

The use of a frequency converter puts higher demands on the cabling and grounding of the drive system. The motor must be cabled by using shielded symmetrical cables and cable glands providing 360° bonding (also called EMC-glands). For motors up to 30 kW unsymmetrical cables can be used, but shielded cables are always recommended.

More information about grounding and cabling of a variable speed drive can be found from the manual

“Grounding and cabling of the drive system” (Code: 3AFY 61201998 R0125 REV A) and the ABB’s Low Voltage Motors Manual.

For fulfilling the EMC requirements, special EMC cable(s) must be used in addition to the correct cable gland mounting, with special, extra earthing pieces. Please refer to the manuals of the frequency converter.

Validity

Measures mentioned in Figure 2 apply to the applicable motors within the General motors range (not high-output versions) with ACS 800 and ACS 550 drives with uncontrolled DC-voltage. For other alternatives and converter types, please contact ABB.

Figure 2. Selection rules for insulation and filtering in variable speed drives

	Motor nominal power P_N or frame size		
	$P_N < 100 \text{ kW}$	$P_N \geq 100 \text{ kW}$ or $\geq \text{IEC 315}$	$P_N \geq 350 \text{ kW}$ $\geq \text{IEC 450}$
$U_N \leq 500 \text{ V}$	Standard motor	Standard motor + Insulated N-bearing	Standard motor + Insulated N-bearing + Common mode filter
$U_N \leq 600 \text{ V}$	Standard motor + dU/dt-filter OR Reinforced insulation	Standard motor + dU/dt-filter (reactor) + Insulated N-bearing OR Reinforced insulation + Insulated N-bearing	Standard motor + Insulated N-bearing + dU/dt-filter + Common mode filter OR Reinforced insulation + Insulated N-bearing + Common mode filter
$U_N \leq 690 \text{ V}$	Reinforced insulation + dU/dt-filter	Reinforced insulation + dU/dt-filter (reactor) + Insulated N-bearing	Reinforced insulation + Insulated N-bearing + dU/dt-filter + Common mode filter

dU/dt filter (reactor)

Series reactor. DU/dt -filter decreases the changing rate of the phase and main voltages and thus reduces voltage stresses in the windings. DU/dt -filters also decrease so-called common mode currents and the risk of bearing currents.

Common mode filters

Common mode filters reduce so-called common mode currents in VSD applications and thus decrease the risk of bearing currents. Common mode filters do not significantly affect the phase or main voltages on the motor terminals.

Insulated Bearings

Bearings with insulated inner or outer races are used as the standard solution. So-called hybrid bearings, i.e. bearings with non-conductive ceramic balls, can also be used in special applications. More information for spare part selection is available on request.

Figure 3. Motor loadability with ACS 600 and ACS 800, Field weakening point 50 Hz.

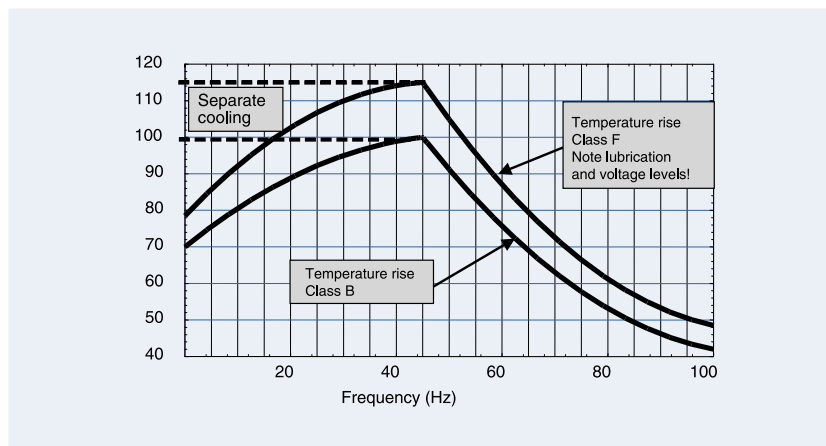

General Purpose Cast Iron Motors

Totally enclosed squirrel cage three phase low voltage motors,
Sizes 71 - 355, 0.25 to 250 kW

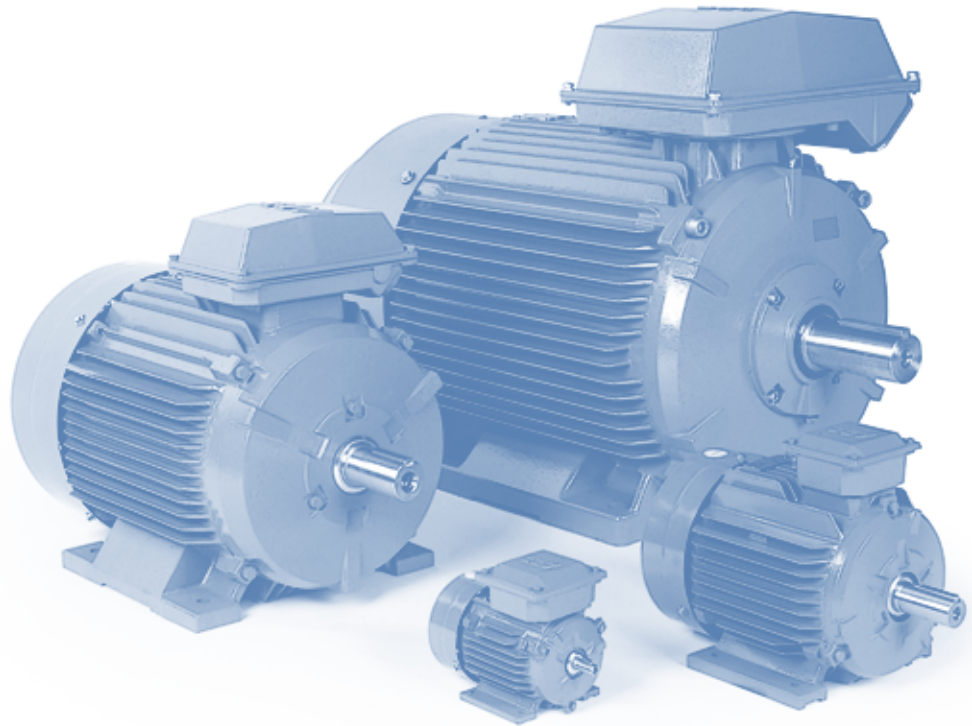

www.abb.com/motor&drives

- > Motors
- > Low voltage motors
- > General purpose motors

Mechanical design.....	114
Ordering information.....	121
Technical data.....	122
Variant codes	130
Dimension drawings	133
Rating plates	142
Construction	143
Cast iron motors in brief.....	144

Mechanical design

Stator

The motor frame including feet, bearing housing and terminal box is made of cast iron. Integrally cast feet allow a very rigid mounting and minimal vibration.

Motors can be supplied for foot mounting, flange mounting and combinations of these.

Drain holes

Motors, frame sizes 280 to 355, are fitted with drain holes and closable plugs. The plugs are open on delivery. When mounting the motors, ensure that the drain holes face downwards.

In the case of vertical mounting, the upper plug must be hammered home completely. In very dusty environments, both plugs should be hammered home.

Drain holes for motors IEC frame sizes 71 to 250 are available as modification.

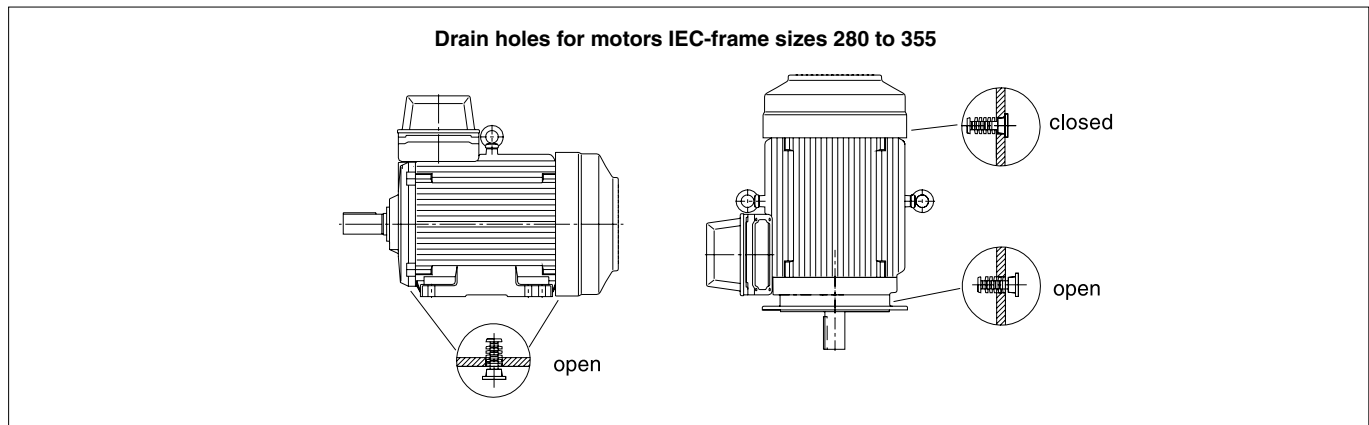

Terminal boxes

Terminal boxes are mounted on top of the motor as standard. The terminal box can also be mounted on the left or right side, see ordering information.

Terminations are suitable for Cu- and Al-cables. Cables are connected to the terminals by cable lugs which are not included with the motor.

The terminal box of motor sizes 71 to 250 can be turned 4x90° and in motors sizes 280 to 355 rotated 2x180° to allow cable entry from either side of the motor. Degree of protection of standard terminal box is IP 55.

To enable the supply of suitable terminations for the motor, please state cable type, quantity and size when ordering. Non-standard design of terminal boxes; e.g. size, degree of protection, are available as options.

The terminal boxes in sizes 280 to 355 are equipped with cable glands or cable boxes as standard.

Please see variant codes for options.

Terminal box examples



Motor sizes 71 to 132



Motor sizes 160 to 250



Motor sizes 280 to 355, provided either with a cable gland or a cable box.

Terminal boxes and cable entries

If no ordering information of the cable is given, it is assumed to be p.v.c.-insulated and termination parts are supplied according to the table below.

In motor sizes 280 to 355 the terminal box is equipped with cable glands or cable boxes as standard.

To enable the supply of suitable terminations for the motor, please state cable type, quantity and size when ordering.

The table below shows the different alternatives available for cable boxes and cable entries. Other types on request.

Cast iron motor sizes 71 to 250 with top-mounted terminal box

Motor size	Poles	Cable entry mm
71M	2,4,6	2xM16x1.5
80M	2,4,6	2xM25x1.5
90S	2,4,6	2xM25x1.5
90L	2,4,6	2xM25x1.5
100L	2,4,6,8	2xM32x1.5
112M	2,4,6,8	2xM32x1.5
132S	2,4,6,8	2xM32x1.5
132M	2,4,6,8	2xM32x1.5

Motor size	Poles	Cable entry mm
160M	2,4,6,8	2xM40x1.5
160L	2,4,6,8	2xM40x1.5
180M	2,4,6,8	2xM40x1.5
180L	2,4,6,8	2xM40x1.5
200L	2,4,6,8	2xM50x1.5
225S	4,6,8	2xM50x1.5
225M	2,4,6,8	2xM50x1.5
250M	2,4,6,8	2xM63x1.5

Cable entries for thermistors: 1xM16x1.5 (type 160 to 250)

Cast iron motor sizes 280 to 355 with top-mounted terminal box

Motor size	Terminal box	Flange opening	Flange	Cable gland	Cable entry	Cable diameter	Auxiliary entries	Terminal bolt
3000 r/min (2 poles)								
280 SM_	122/2	C	3GZF 294 730-749	3GZF 294 730-613	2 x M63	2 x Ø32-49	2 x M20	M8
315 SM_, ML_	142/1	D	3GZF 294 730-753	3GZF 294 730-613	2 x M63	3 x Ø32-49	2 x M20	M10
355 S	162/1	E-D	3GZF 294 730-753	3GZF 294 730-613	2 x M63	3 x Ø32-49	2 x M20	M12
1500 r/min (4 poles)								
280 SM_	122/2	C	3GZF 294 730-749	3GZF 294 730-613	2 x M63	2 x Ø32-49	2 x M20	M8
315 SM_, ML_	142/1	D	3GZF 294 730-753	3GZF 294 730-613	2 x M63	3 x Ø32-49	2 x M20	M10
355 S	162/1	E-D	3GZF 294 730-753	3GZF 294 730-613	2 x M63	3 x Ø32-49	2 x M20	M12
1000 r/min (6 poles)								
280 SM_	122/2	C	3GZF 294 730-749	3GZF 294 730-613	2 x M63	2 x Ø32-49	2 x M20	M8
315 SM_, ML_	142/1	D	3GZF 294 730-753	3GZF 294 730-613	2 x M63	3 x Ø32-49	2 x M20	M10
355 S	142/2	D	3GZF 294 730-753	3GZF 294 730-613	2 x M63	3 x Ø32-49	2 x M20	M10
750 r/min (8 poles)								
280 SM_	122/2	C	3GZF 294 730-749	3GZF 294 730-613	2 x M63	2 x Ø32-49	2 x M20	M8
315 SM_, ML_	142/1	D	3GZF 294 730-753	3GZF 294 730-613	2 x M63	3 x Ø32-49	2 x M20	M10
355 S	142/2	D	3GZF 294 730-753	3GZF 294 730-613	2 x M63	3 x Ø32-49	2 x M20	M10

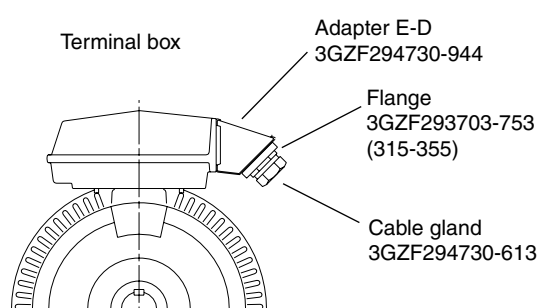
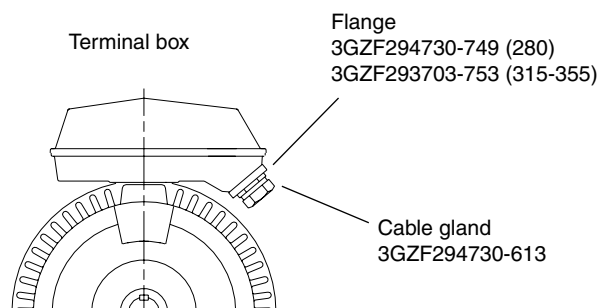

Alternatives for cable entries and cable boxes for motor sizes 280 to 355

Motor size	Terminal box on top	Terminal box on side	Opening type (D/Y-conn.)	Max. rated current A mm ²	Max connection cable area	Cable gland diameter	Auxiliary cable entries	Cable box diameter	Blank plate
280	122/2	NA	C	363/210	2 x 150	2 x M40-63	2 x M20	max 2xØ60	MKLN 20
315	142/1	NA	D	640/370	2 x 240	1 x M40-63	2 x M20	max 2xØ60	MKLN 30
355	142/2		D	640/370	2 x 240	2 x M40-63	2 x M20	max 2xØ80	
	162/1		E-D	950/550	4 x 240			max 4xØ60	

Flange

Opening	Adapter 3GZF	c	e	f	g	d
C		62	193	62	193	M8
D		100	300	80	292	M10
E		100	300	80	292	M10
E-D	294730-944	100	300	80	292	M10

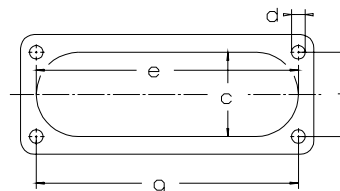

Bearings

The motors are normally fitted with single-row deep groove ball bearings as listed in the table below.

When there are high axial forces, angular-contact ball bearings should be used. This option is available on request.

When a motor with angular-contact ball bearings is ordered, the method of mounting and direction and magnitude of the axial force must be specified. For special bearings, please see the variant codes.

Basic version with deep groove ball bearings

Motor size	Number of poles	Deep groove ball bearings	
		D-end	N-end
71M	2-6	6202 VV C3	6202 VV C3
80M	2-6	6204 DDU C3	6204 DDU C3
90S	2-6	6205 DDU C3	6205 DDU C3
90L	2-6	6205 DDU C3	6205 DDU C3
100L	2-8	6206 DDU C3	6206 DDU C3
112M	2-8	6207 DDU C3	6206 DDU C3
132S	2-8	6208 DDU C3	6207 DDU C3
132M	2-8	6208 DDU C3	6207 DDU C3
160M	2-8	6309 DDU C3	6209 DDU C3
160L	2-8	6309 DDU C3	6209 DDU C3

Motor size	Number of poles	Deep groove ball bearings	
		D-end	N-end
180M	2-8	6310 DDU C3	6210 DDU C3
180L	2-8	6310 DDU C3	6210 DDU C3
200L	2-8	6312 DDU C3	6212 DDU C3
225S	4-8	6313 ZZ C3	6213 ZZ C3
225M	2-8	6313 ZZ C3	6213 ZZ C3
250M	2-8	6314/C3	6214/C3
280	2	6316/C4	6316/C4
	4-12	6316/C3	6316/C3
315	2	6316/C4	6316/C4
	4-12	6319/C3	6316/C3
355	2	6316/C3	6316/C3
	4-12	6322/C3	6319/C3

Axially-locked bearings

The D-end bearing is locked, in sizes 71 to 180 with the spring ring and in sizes 200 to 355 with the inner bearing cover. The inner ring is locked by tight tolerance to the shaft.

Transport locking

Motors that have roller bearings or an angular contact ball bearing are fitted with a transport lock before despatch to prevent damage to the bearings during transport. In case of transport locked bearing, motor sizes 280 to 355 are provided with a warning sign.

Locking may also be fitted in other cases where transport conditions are suspected of being potentially damaging.

Bearing seals

The motors are as standard provided with seals according to table below.

Motor size	Description D-end	Standard design		Alternative design Radial seal (DIN 3760) Variant code 072	Number of poles	d ₁	d ₂	B ₁	b
		Axial seal	N-end						
71 to 132	Sealed bearings (2RS) and axial seal, gamma ring, at D-end								
160 to 225	Axial seal, gamma ring, at D-end								
250	Radial seal at D-end								
280	Axial seals at both ends	VS 80	VS 80	80x100x10 ¹⁾	2	80	100	13.5	10
		VS 80	VS 80	80x100x10	4-12	80	100	13.5	10
315	Axial seals at both ends	VS 80	VS 80	80x100x10 ¹⁾	2	80	100	13.5	10
		VS 95	VS 80	95x120x12	4-12	95	120	13.5	12
355	Axial seals at both ends	VS 80	VS 80	80x100x10 ¹⁾	2	80	100	13.5	10
		VS 110	VS 95	110x140x12 ¹⁾	4-12	110	140	15.5	12

¹⁾ Viton-seal

Motor sizes 71-132

Motor sizes 160-225

Motor size 250

Motor sizes 280-355

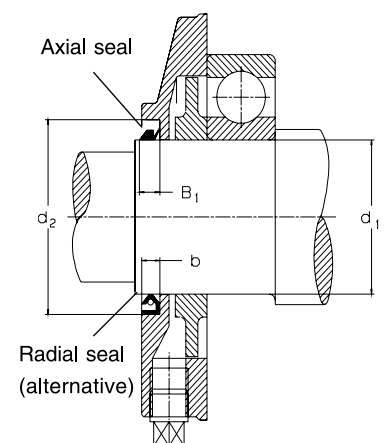
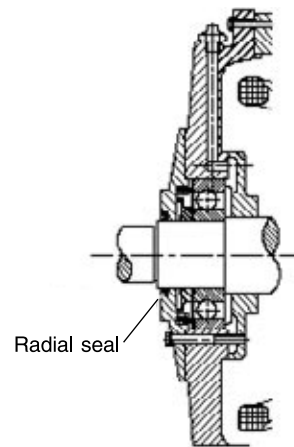
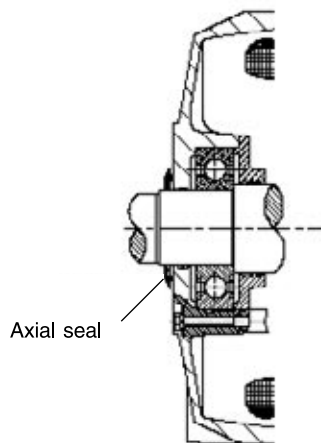
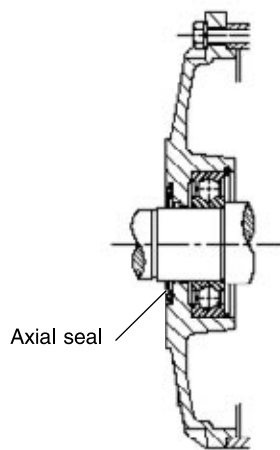

Bearing life

The nominal life L_{10} of a bearing is defined according to ISO as the number of operating hours achieved or exceeded by 90% of identical bearings in a large test series under certain specified conditions. 50% of the bearings achieve at least five times this figure.

The calculated bearing life L_{10} for power transmission by means of a coupling (horizontal machine):

Motor sizes 280 to 355 200,000 hours.

Lubrication

On delivery, the motors are lubricated with a type of grease intended for use in dry or humid environments, at normal ambient temperature.

Standard versions of motors 71 to 225 are lubricated for life, with lithium based grease.

Motors 160 to 225 are available with either permanent greased or, as against variant codes, with regreasable bearings.

Motors 250 to 355 have grease value lubrication for lubrication in service. The lubrication intervals and quantity are stated in the maintenance manual which comes with the motor.

Pulley diameter

When the desired bearing life has been determined, the minimum permissible pulley diameter can be calculated with FR (or FRX), according to the formula:

$$D = \frac{1.9 \cdot 10^7 \cdot K \cdot P}{N \cdot F_R}$$

Where:

D = diameter of pulley, mm

P = power requirement, kW

N = motor speed, r /min

K = belt tension factor, dependent on belt type and type of duty. A common value for V belts is K= 2.5

F_R = permissible radial force

Permissible loadings on shaft

4 The tables below give the permissible radial force in Newtons, assuming zero axial force. The values are based on normal conditions at 50 Hz and calculated bearing lives of 20,000 and 40,000 hours.

Motors are foot-mounted IM B3 version with force directed sideways. In some cases the strength of the shaft affects the permissible forces.

At 60 Hz the values must be reduced by 10 %.

If the radial force is applied between points X₀ and X_{max}, the permissible force F_R can be calculated from the following formula:

$$F_R = F_{X_0} - \frac{X}{E} (F_{X_0} - F_{X_{max}})$$

E = length of shaft extension in basic version

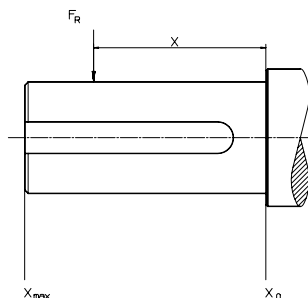

Permissible radial forces

Motor size	Poles	Length of shaft extension E (mm)	Radial forces Ball bearings 20,000 hours		40,000	
			X ₀ (N)	F _{X_{max}} (N)	X ₀ (N)	X _{max} (N)
71 M	2	30	381	322	303	256
	4	30	480	405	381	322
	6	30	555	469	441	372
80 M	2	40	624	509	495	404
	4	40	788	643	626	511
	6	40	907	740	720	587
	8	40	997	813	791	646
90 S	2	40	686	542	545	430
	4	40	870	687	690	545
	6	40	1000	790	794	627
	8	40	1095	866	870	687

Permissible radial forces

Motors size	Poles	Length of shaft extension E (mm)	Radial forces Ball bearings 20,000 hours			
			X_0 (N)	FX_{max} (N)	X_0 (N)	X_{max} (N)
90 L	2	50	696	564	553	448
	4	50	885	717	702	569
	6	50	1015	823	806	653
	8	50	1112	901	883	715
100 L	2	60	979	785	777	622
	4	60	1234	989	979	785
	6	60	1419	1137	1126	903
	8	60	1566	1255	1243	996
112 M	2	60	1258	1014	998	805
	4	60	1592	1284	1264	1019
	6	60	1831	1477	1453	1172
	8	60	2020	1629	1603	1293
132 S	2	80	1435	1122	1139	890
	4	80	1821	1423	1445	1130
	6	80	2079	1625	1650	1290
	8	80	2299	1797	1825	1427
132 M	4	80	1840	1476	1461	1172
	6	80	2107	1690	1672	1341
	8	80	2329	1869	1849	1483
160 M	2	110	1544	1200	1226	952
	4	110	1948	1513	1546	1201
	6	110	2232	1734	1772	1377
	8	110	2465	1916	1957	1520
160L	2	110	1563	1243	1240	987
	4	110	1971	1568	1565	1244
	6	110	2259	1797	1793	1426
	8	110	2495	1984	1980	1575
180M	2	110	2984	2371	2368	1882
	4	110	3759	2988	2984	2371
180L	4	110	3802	3073	3017	2439
	6	110	4352	3518	3454	2792
	8	110	4800	3881	3810	3080
200L	2	110	4090	3377	3246	2680
	4	110	5162	4262	4097	3383
	6	110	5909	4879	4690	3872
	8	110	6518	5382	5173	4272
225S	4	140	5763	4526	4574	4593
	8	140	7261	5703	5763	4526
225M	2	110	4591	3811	3644	3025
	4	110	5791	4594	4596	3646
	6	110	6644	5271	5273	4184
	8	110	7296	5788	5791	4594
250M	2	140	5112	4170	4057	3310
	4	140	6440	5254	5111	4170
	6	140	7388	6027	5864	4784
	8	140	8113	6619	6439	5253
280SM_	2	140	7300	6200	5800	4900
	4	140	9200	7800	7300	6200
	6	140	10600	8900	8400	7100
	8	140	11600	9800	9200	7800
315SM_	2	140	7300	6000	5800	4950
	4	170	11300	9400	9000	7500
	6	170	13000	10600	10300	8500
	8	170	14300	10400	11300	9400
315ML	2	140	7300	6000	5800	4950
	4	140	11300	9400	9000	7500
	6	140	13000	10600	10300	8500
	8	140	14300	10400	11300	9400
355 S_	2	140	7400	6400	5100	5800
	4	210	15200	12500	12000	9850
	6	210	17300	14200	13700	11300
	8	210	19000	15600	15200	12400

Ordering information

When placing an order, please state the following minimum data in the order, as in the example.

The product code of the motor is composed in accordance with the following example.

Motor type	M2QA 90S4A
Pole number	4
Mounting arrangement (IM-code)	IM B3 (IM 1001)
Rated output	1.1 kW
Product code	3GQA092101-ADA
Variant codes if needed	

A	B	C	D, E, F	G	A Motor type
M2QA	90S4A	3GQA	092	101 - AD A	B Motor size
				003 etc.	C Product code
					D Mounting arrangement code
					E Voltage and frequency code
					F Generation code
					G Variant codes

Explanation of the product code (C, D, E, F):

Positions 1 to 4

3GQA = Totally enclosed fan cooled squirrel cage motor with cast iron frame

Positions 5 and 6

IEC frame

07 = 71	11 = 112	20 = 200	31 = 315
08 = 80	13 = 132	22 = 225	35 = 355
09 = 90	16 = 160	25 = 250	
10 = 100	18 = 180	28 = 280	

Position 7

Speed (Pole pairs)

1 = 2 poles	6 = 12 poles
2 = 4 poles	7 = >12 poles
3 = 6 poles	8 = Two-speed motors
4 = 8 poles	9 = Multi-speed motors
5 = 10 poles	

Positions 8 to 10

Serial number

Position 11

- (dash)

Position 12

Mounting arrangement

A = Foot-mounted, top-mounted terminal box
R = Foot-mounted, terminal box on RHS, seen from D-end
L = Foot-mounted, terminal box on LHS, seen from D-end
B = Flange-mounted, large flange
C = Flange-mounted, small flange sizes (71-112)
H = Foot- and flange-mounted

Position 13

Voltage and frequency code

See tables on appropriate page

Position 14

Generation code

A, B, C...

The product code must be, if needed, followed by variant codes.

Code letters for supplementing the product code for voltage and frequency:

A	B	D	E	F	H
380 VY 50 Hz	380 V 50 Hz	380-420 V 50 Hz 660-690 VY 50 Hz 440-480 ¹⁾ V 60 Hz	500 V 50 Hz 575 V 60 Hz	500 VY 50 Hz 575 VY 60 Hz	415 V 50 Hz
S	T	U	X		
220-240 V 50 Hz 380-420 VY 50 Hz 440-480 VY 60 Hz	660 V 50 Hz	690 V 50 Hz	Other rated voltage, connection or frequency, max. 690 V		¹⁾ 480 V not stamped on sizes 160 to 250

General purpose cast iron motors

Technical data for totally enclosed squirrel cage three phase motors



IP 55 – IC 411 – Insulation class F, temperature rise class B

Output kW	Motor type	Product code	Speed r/min	Efficiency		Power factor cos 100%	Current		Torque				
				Full load 100%	3/4 load 75%		I_N A	I_s A	T_N Nm	T_s Nm	T_{max} Nm		
3000 r/min = 2-poles			400 V 50 Hz				Basic design						
0.37	M2QA	71 M2A	3GQA	071 301-••A	2780	70.0	68.0	0.81	0.94	6.1	1.27	2.2	3.0
0.55	M2QA	71 M2B	3GQA	071 302-••A	2785	73.0	72.4	0.82	1.33	6.1	1.89	2.2	2.7
0.75	M2QA	80 M2A	3GQA	081 301-••A	2840	75.0	75.5	0.85	1.7	6.1	2.52	2.2	3.0
1.1	M2QA	80 M2B	3GQA	081 302-••A	2855	78.0	77.9	0.85	2.4	7.0	3.68	2.2	2.2
1.5	M2QA	90 S2A	3GQA	091 101-••A	2850	79.0	79.0	0.87	3.15	7.0	5.03	2.2	2.5
2.2	M2QA	90 L2A	3GQA	091 501-••A	2850	81.5	81.8	0.86	4.53	7.0	7.37	2.2	3.5
3	M2QA	100 L2A	3GQA	101 501-••A	2860	83.0	83.2	0.88	5.93	7.0	10.02	2.2	3.0
4	M2QA	112 M2A	3GQA	111 301-••A	2900	85.0	84.6	0.9	7.55	7.0	13.17	2.2	3.2
5.5	M2QA	132 S2A	3GQA	131 101-••A	2920	87.5	87.9	0.89	10.2	7.0	17.99	2.2	3.0
7.5	M2QA	132 S2B	3GQA	131 102-••A	2920	88.5	90.1	0.9	13.6	7.0	24.53	2.2	3.5
11	M2QA	160 M2A	3GQA	161 301-••A	2930	90.0	90.5	0.89	19.82	6.5	35.85	2.5	3.1
15	M2QA	160 M2B	3GQA	161 302-••A	2920	90.0	90.1	0.89	27.03	6.5	49.06	2.5	2.6
18.5	M2QA	160 L2A	3GQA	161 501-••A	2930	90.5	90.9	0.9	32.78	6.5	60	2.5	2.7
22	M2QA	180 M2A	3GQA	181 301-••A	2940	90.8	91.0	0.9	38.86	6.5	71	2.3	2.5
30	M2QA	200 L2A	3GQA	201 501-••A	2955	91.4	91.1	0.9	52	6.5	96	2.2	2.6
37	M2QA	200 L2B	3GQA	201 502-••A	2955	92.2	91.8	0.9	64	6.5	119	2.3	2.6
45	M2QA	225 M2A	3GQA	221 301-••A	2970	92.6	92.2	0.89	78	7.0	144	2.5	2.7
55	M2QA	250 M2A	3GQA	251 301-••A	2960	93.4	91.7	0.89	96	7.5	177	2.4	2.7
75	M2BAT	280 SMA	3GBA	281 210-••D	2974	94.1	93.6	0.87	134	6.7	241	1.7	2.6
90	²⁾ M2BAT	280 SMB	3GBA	281 220-••D	2970	94.5	94.2	0.89	156	6.4	289	1.7	2.5
110	M2BAT	315 SMA	3GBA	311 210-••D	2979	94.1	93.4	0.85	198	6.3	353	1.5	2.5
132	²⁾ M2BAT	315 SMB	3GBA	311 220-••D	2977	94.7	94.1	0.87	232	6.3	423	1.7	2.5
160	²⁾ M2BAT	315 SMC	3GBA	311 230-••D	2976	95.1	94.8	0.88	273	6.2	513	1.7	2.4
200	²⁾ M2BAT	315 MLA	3GBA	311 410-••D	2980	95.7	95.3	0.88	345	7.9	641	2.6	3.1
250	M2BAT	355 S	3GBA	351 100-••D	2983	95.7	95.3	0.89	424	6.8	800	1.5	2.8
3000 r/min = 2-poles			400 V 50 Hz				High-output design						
5.5	¹⁾ M2QA	112 L2 A	3GQA	111 501-••A	2900	82.0		0.9	10.76	7.0	18.1	2.0	2.1
9.2	¹⁾ M2QA	132 M2A	3GQA	131 301-••B	2910	85.5		0.88	17.65	7.5	30.2	2.0	2.2
11	¹⁾ M2QA	132 M2B	3GQA	131 302-••B	2900	88.0		0.9	20.05	8.0	36.2	2.2	2.2
22	¹⁾ M2QA	160 L2B	3GQA	161 502-••A	2930	88.0		0.9	40.09	6.5	71	2.3	2.8
30	¹⁾ M2QA	180 L2A	3GQA	181 501-••A	2950	90.8		0.9	53	6.5	97	2.3	2.8
45	¹⁾ M2QA	200 L2C	3GQA	201 503-••A	2955	92.0		0.9	78	7.0	145	2.2	2.6
55	¹⁾ M2QA	225 M2B	3GQA	221 302-••A	2975	92.6		0.89	96	7.0	177	2.5	2.8
75	¹⁾ M2QA	250 M2B	3GQA	251 302-••A	2970	91.0		0.89	134	7.0	241	2.4	2.8
110	²⁾ M2BAT	280 SMC	3GBA	281 230-••D	2973	95.0	94.8	0.9	187	6.7	353	1.9	2.6

¹⁾ Temperature rise class F by voltage 400 V 50 Hz.

²⁾ Temperature rise class F by voltage 380 V 50 Hz.

Missing data on request.

The two bullets in the product code indicate choice of mounting arrangement, voltage and frequency (see ordering information page).

General purpose cast iron motors

Technical data for totally enclosed squirrel cage three phase motors

IP 55 – IC 411 – Insulation class F, temperature rise class B

Output kW	Motor type	Speed r/min	Efficiency %	Power factor cos	Current I _N A	Speed r/min	Efficiency %	Power factor cos	Current I _N A	Moment of inertia J=1/4 GD ² kgm ²	Weight kg	Sound pressure level L _p dB(A)	
3000 r/min = 2-poles		380 V 50 Hz				415 V 50 Hz				Basic design			
0.37	M2QA 71 M2A	2765	70.0	0.83	0.97	2795	70.0	0.79	0.93	0.0003	10	56	
0.55	M2QA 71 M2B	2780	73.0	0.84	1.37	2800	73.0	0.79	1.33	0.00037	11	56	
0.75	M2QA 80 M2A	2825	75.5	0.86	1.75	2855	75.0	0.85	1.64	0.00091	16	57	
1.1	M2QA 80 M2B	2840	77.5	0.86	2.52	2870	78.0	0.83	2.37	0.00107	17	58	
1.5	M2QA 90 S2A	2835	79.0	0.9	3.23	2865	79.0	0.86	3.08	0.00135	21	61	
2.2	M2QA 90 L2A	2835	81.5	0.89	4.61	2865	81.0	0.83	4.56	0.00163	24	61	
3	M2QA 100 L2A	2845	83.0	0.9	6.14	2875	83.5	0.86	5.85	0.00402	33	65	
4	M2QA 112 M2A	2885	85.0	0.92	7.82	2915	85.0	0.87	7.53	0.00671	42	67	
5.5	M2QA 132 S2A	2905	87.5	0.9	10.7	2935	88.0	0.88	9.94	0.01241	58	70	
7.5	M2QA 132 S2B	2905	87.5	0.9	14.5	2935	89.0	0.9	13.1	0.01491	63	70	
11	M2QA 160 M2A	2918	90.0	0.91	20.41	2930	90.0	0.87	19.54	0.0436	112	72	
15	M2QA 160 M2B	2917	90.0	0.91	27.82	2932	90.0	0.88	26.35	0.0551	122	72	
18.5	M2QA 160 L2A	2920	90.5	0.91	34.13	2935	90.5	0.89	31.95	0.06549	142	72	
22	M2QA 180 M2A	2940	90.8	0.91	40.45	2955	90.8	0.88	38.3	0.08805	170	72	
30	M2QA 200 L2A	2950	91.2	0.91	54	2960	91.3	0.89	51	0.14821	235	81	
37	M2QA 200 L2B	2950	91.7	0.91	67	2960	92.3	0.89	62	0.16822	254	81	
45	M2QA 225 M2A	2965	92.2	0.90	82	2975	92.6	0.87	77	0.29345	328	81	
55	M2QA 250 M2A	2956	93.2	0.90	100	2962	93.5	0.88	93	0.3784	390	84	
75	M2BAT 280 SMA	2970	94.0	0.88	137	2976	94.2	0.86	130	0.7	570	78	
90 ²⁾	M2BAT 280 SMB	2966	94.2	0.89	163	2974	94.6	0.88	151	0.82	610	78	
110	M2BAT 315 SMA	2976	94.1	0.86	208	2980	94.1	0.83	197	1.05	820	83	
132 ²⁾	M2BAT 315 SMB	2974	94.5	0.87	243	2979	94.7	0.85	230	1.25	870	83	
160 ²⁾	M2BAT 315 SMC	2972	95.0	0.88	290	2978	95.2	0.88	265	1.5	960	83	
200 ²⁾	M2BAT 315 MLA	2978	95.6	0.89	358	2982	95.7	0.87	335	1.95	1130	83	
250	M2BAT 355 S	2981	95.7	0.90	440	2984	95.7	0.88	412	2.7	1500	83	
3000 r/min = 2-poles		380 V 50 Hz				415 V 50 Hz				High-output design			
5.5 ¹⁾	M2QA 112 L2 A									0.008263	49	70	
9.2 ¹⁾	M2QA 132 M2A									0.014995	68	71	
11 ¹⁾	M2QA 132 M2B									0.01768	73	73	
22 ¹⁾	M2QA 160 L2B									0.06549	130	75	
30 ¹⁾	M2QA 180 L2A									0.10339	185	75	
45 ¹⁾	M2QA 200 L2C									0.18473	276	81	
55 ¹⁾	M2QA 225 M2B									0.33431	340	81	
75 ¹⁾	M2QA 250 M2B									0.45829	411	85	
110 ²⁾	M2BAT 280 SMC	2968	94.8	0.90	198	2975	95.1	0.89	180	1.05	660	78	

¹⁾ Temperature rise class F by voltage 400 V 50 Hz.

²⁾ Temperature rise class F by voltage 380 V 50 Hz.

Missing data on request.

General purpose cast iron motors

Technical data for totally enclosed squirrel cage three phase motors



IP 55 – IC 411 – Insulation class F, temperature rise class B

Output kW	Motor type	Product code	Speed r/min	Efficiency		Power factor cos 100%	Current		Torque			
				Full load 100%	3/4 load 75%		I_N A	I_s A	T_N Nm	T_s Nm	T_{max} Nm	
1500 r/min = 4-poles			400 V 50 Hz			Basic design						
0.25	M2QA	71 M4A	3GQA 072 301-↔A	1395	65.5	63.3	0.72	0.77	5.2	1.71	2.1	2.7
0.37	M2QA	71 M4B	3GQA 072 302-↔A	1395	68.5	69.4	0.75	1.04	5.2	2.53	2.1	2.7
0.55	M2QA	80 M4A	3GQA 082 301-↔A	1410	73.5	71.4	0.72	1.5	5.2	3.73	2.4	2.7
0.75	M2QA	80 M4B	3GQA 082 302-↔A	1415	74.5	75.2	0.75	1.93	6.0	5.06	2.4	2.6
1.1	M2QA	90 S4A	3GQA 092 101-↔A	1400	77.5	77.8	0.78	2.65	6.0	7.5	2.3	2.4
1.5	M2QA	90 L4A	3GQA 092 501-↔A	1390	78.5	79.2	0.79	3.5	6.0	10.31	2.3	2.6
2.2	M2QA	100 L4A	3GQA 102 501-↔A	1430	81.5	82.3	0.81	4.85	6.0	14.69	2.3	2.7
3	M2QA	100 L4B	3GQA 102 502-↔A	1420	82.8	82.5	0.83	6.3	6.5	20.18	2.3	2.8
4	M2QA	112 M4A	3GQA 112 301-↔A	1430	85.0	84.6	0.82	8.29	6.5	26.71	2.3	2.8
5.5	M2QA	132 S4A	3GQA 132 101-↔A	1430	86.0	87.1	0.85	10.9	6.5	36.73	2.3	2.9
7.5	M2QA	132 M4A	3GQA 132 301-↔A	1440	88.5	88.3	0.85	14.4	6.5	49.74	2.3	2.7
11	M2QA	160 M4A	3GQA 162 301-↔A	1460	89.5	90.0	0.85	20.87	6.5	71	2.4	2.8
15	M2QA	160 L4A	3GQA 162 501-↔A	1460	90.0	90.4	0.86	27.97	6.5	98	2.3	2.6
18.5	M2QA	180 M4A	3GQA 182 301-↔A	1470	91.0	90.9	0.86	34.12	6.5	120	2.3	3.4
22	M2QA	180 L4A	3GQA 182 501-↔A	1470	91.5	90.0	0.88	39.44	6.5	142	2.4	3.0
30	M2QA	200 L4A	3GQA 202 501-↔A	1470	92.2	91.8	0.88	53	6.5	194	2.2	2.9
37	M2QA	225 S4A	3GQA 222 101-↔A	1480	92.6	91.2	0.85	67	7.0	238	2.2	2.7
45	M2QA	225 M4A	3GQA 222 301-↔A	1480	92.8	91.7	0.87	80	7.0	290	2.2	2.7
55	M2QA	250 M4A	3GQA 252 301-↔A	1480	93.4	91.3	0.87	98	7.0	354	2.4	2.7
75 ²⁾	M2BAT	280 SMA	3GBA 282 210-↔D	1483	94.2	94.2	0.83	138	6.3	483	2.1	2.6
90 ²⁾	M2BAT	280 SMB	3GBA 282 220-↔D	1481	94.6	94.7	0.86	162	6.4	580	2.1	2.4
110 ²⁾	M2BAT	315 SMA	3GBA 312 210-↔D	1486	94.6	94.2	0.84	203	6.4	707	1.7	2.3
132 ²⁾	M2BAT	315 SMB	3GBA 312 220-↔D	1485	94.9	94.7	0.85	239	6.1	849	1.9	2.4
160 ²⁾	M2BAT	315 SMC	3GBA 312 230-↔D	1486	95.4	95.2	0.85	286	6.7	1028	2.1	2.6
200 ²⁾	M2BAT	315 MLA	3GBA 312 410-↔D	1485	95.7	95.6	0.86	354	6.4	1286	2.1	2.5
250	M2BAT	355 S	3GBA 352 100-↔D	1488	95.6	95.3	0.85	448	6.7	1604	2.0	2.6
1500 r/min = 4-poles			400 V 50 Hz			High-output design						
5.5 ¹⁾	M2QA	112 L4A	3GQA 112 501-↔A	1430	84.0		0.83	11.39	7.0	36.7	2.2	2.2
9.2 ¹⁾	M2QA	132 M4B	3GQA 132 302-↔A	1430	84.0		0.85	18.6	6.5	61	2.2	2.2
11 ¹⁾	M2QA	132 M4C	3GQA 132 303-↔A	1430	84.5		0.85	22.11	6.5	73	2.2	2.2
18.5 ¹⁾	M2QA	160 L4B	3GQA 162 502-↔A	1460	87.0		0.86	35.69	6.5	121	2.2	2.4
30 ¹⁾	M2QA	180 L4B	3GQA 182 502-↔A	1470	89.0		0.88	55	6.5	195	2.2	2.6
37 ¹⁾	M2QA	200 L4B	3GQA 202 502-↔A	1470	89.2		0.88	68	6.5	240	2.2	2.6
55 ¹⁾	M2QA	225 M4B	3GQA 222 302-↔A	1480	91.0		0.87	100	7.0	355	2.3	2.4
75 ¹⁾	M2QA	250 M4B	3GQA 252 302-↔A	1480	90.4		0.87	137	7.0	484	2.3	2.4
110 ²⁾	M2BAT	280 SMC	3GBA 282 230-↔D	1484	95.1	95.1	0.85	196	7.1	708	2.7	2.8

¹⁾ Temperature rise class F by voltage 400 V 50 Hz.

²⁾ Temperature rise class F by voltage 380 V 50 Hz.

Missing data on request.

The two bullets in the product code indicate choice of mounting arrangement, voltage and frequency (see ordering information page).

General purpose cast iron motors

Technical data for totally enclosed squirrel cage three phase motors

IP 55 – IC 411 – Insulation class F, temperature rise class B

Output kW	Motor type	Speed r/min	Efficiency %	Power factor cos	Current I _N A	Speed r/min	Efficiency %	Power factor cos	Current I _N A	Moment of inertia J=1/4 GD ² kgm ²	Weight kg	Sound pressure level L _p dB(A)
1500 r/min = 4-poles		380 V 50 Hz			415 V 50 Hz			Basic design				
0.25	M2QA 71 M4A	1385	66.0	0.74	0.78	1405	64.0	0.69	0.79	0.00053	11	43
0.37	M2QA 71 M4B	1385	69.0	0.78	1.05	1405	68.0	0.71	1.07	0.00066	11	45
0.55	M2QA 80 M4A	1400	73.5	0.75	1.52	1420	72.5	0.68	1.55	0.00145	16	46
0.75	M2QA 80 M4B	1405	74.5	0.78	1.97	1425	74.0	0.72	1.96	0.00174	17	46
1.1	M2QA 90 S4A	1390	77.0	0.80	2.72	1410	77.5	0.75	2.65	0.00254	21	52
1.5	M2QA 90 L4A	1380	78.5	0.80	3.64	1400	78.5	0.77	3.48	0.00317	25	52
2.2	M2QA 100 L4A	1420	81.5	0.82	4.98	1440	81.4	0.78	4.85	0.00679	32	53
3	M2QA 100 L4B	1410	82.5	0.85	6.5	1430	82.7	0.82	6.17	0.00862	36	53
4	M2QA 112 M4A	1420	84.5	0.84	8.57	1440	85.0	0.8	8.24	0.01306	45	56
5.5	M2QA 132 S4A	1420	85.5	0.87	11.3	1440	86.5	0.83	10.7	0.02673	60	59
7.5	M2QA 132 M4A	1430	88.0	0.85	15.2	1450	88.0	0.84	14.1	0.03432	73	59
11	M2QA 160 M4A	1455	89.5	0.87	21.46	1463	89.5	0.83	20.6	0.06543	116	66
15	M2QA 160 L4A	1452	90.0	0.88	28.78	1461	90.0	0.85	27.28	0.09349	137	66
18.5	M2QA 180 M4A	1465	91.0	0.88	35.1	1470	91.0	0.82	34.49	0.16049	170	66
22	M2QA 180 L4A	1465	91.5	0.90	40.59	1475	91.5	0.86	38.9	0.18046	186	66
30	M2QA 200 L4A	1465	92.3	0.89	55	1470	86.8	0.87	55	0.2819	254	71
37	M2QA 225 S4A	1475	92.3	0.85	71	1480	92.0	0.82	68	0.37	308	73
45	M2QA 225 M4A	1475	92.6	0.88	83	1480	92.8	0.85	79	0.42	335	73
55	M2QA 250 M4A	1477	93.2	0.88	102	1482	93.6	0.86	95	0.78	450	76
75	²⁾ M2BAT 280 SMA	1480	94.0	0.85	143	1484	94.2	0.82	137	1.05	560	71
90	²⁾ M2BAT 280 SMB	1478	94.2	0.86	169	1483	94.7	0.85	157	1.32	600	71
110	²⁾ M2BAT 315 SMA	1484	94.5	0.85	209	1487	94.6	0.82	198	1.9	800	78
132	²⁾ M2BAT 315 SMB	1483	94.8	0.86	248	1486	95.0	0.84	232	2.2	855	78
160	²⁾ M2BAT 315 SMC	1483	95.0	0.86	300	1487	95.4	0.84	279	2.6	930	78
200	²⁾ M2BAT 315 MLA	1482	95.2	0.86	375	1486	95.7	0.85	343	3.2	1030	78
250	M2BAT 355 S	1487	95.6	0.86	465	1489	95.6	0.84	438	5.4	1500	82
1500 r/min = 4-poles		380 V 50 Hz			415 V 50 Hz			High-output design				
5.5	¹⁾ M2QA 112 L4A									0.01484	49	64
9.2	¹⁾ M2QA 132 M4B									0.0347	75	71
11	¹⁾ M2QA 132 M4C									0.04227	80	73
18.5	¹⁾ M2QA 160 L4B									0.10686	147	66
30	¹⁾ M2QA 180 L4B									0.20783	200	70
37	¹⁾ M2QA 200 L4B									0.29715	277	72
55	¹⁾ M2QA 225 M4B									0.6244	351	75
75	¹⁾ M2QA 250 M4B									0.9125	485	77
110	²⁾ M2BAT 280 SMC	1481	94.8	0.86	204	1485	95.2	0.84	191	1.7	660	71

¹⁾ Temperature rise class F by voltage 400 V 50 Hz.

²⁾ Temperature rise class F by voltage 380 V 50 Hz.

Missing data on request.

General purpose cast iron motors

Technical data for totally enclosed squirrel cage three phase motors

IP 55 – IC 411 – Insulation class F, temperature rise class B

Output kW	Motor type	Product code	Speed r/min	Efficiency		Power factor cos 100%	Current		Torque			
				Full load 100%	3/4 load 75%		I_N A	I_s A	T_N Nm	T_s Nm	T_{max} Nm	
1000 r/min = 6-poles			400 V 50 Hz			Basic design						
0.18	M2QA 71 M6A	3GQA 073 301-••A	910	55.0	50.1	0.65	0.73	4.0	1.89	1.8	2.4	
0.25	M2QA 71 M6B	3GQA 073 302-••A	890	60.0	58.3	0.65	0.93	4.0	2.68	1.8	2.5	
0.37	M2QA 80 M6A	3GQA 083 301-••A	930	63.0	63.2	0.66	1.29	5.0	3.8	1.9	2.0	
0.55	M2QA 80 M6B	3GQA 083 302-••A	925	65.0	65.1	0.68	1.8	5.0	5.68	1.9	1.8	
0.75	M2QA 90 S6A	3GQA 093 101-••A	920	71.0	70.2	0.72	2.12	5.0	7.79	2.0	2.3	
1.1	M2QA 90 L6A	3GQA 093 501-••A	920	73.0	73.1	0.74	2.94	5.0	11.42	2.0	2.6	
1.5	M2QA 100 L6A	3GQA 103 501-••A	940	76.0	75.3	0.77	3.78	5.5	15.24	2.0	2.4	
2.2	M2QA 112 M6A	3GQA 113 301-••A	940	80.0	81.2	0.76	5.23	5.5	22.35	2.0	2.3	
3	M2QA 132 S6A	3GQA 133 101-••A	960	82.5	83.5	0.78	6.73	6.5	29.84	2.0	2.4	
4	M2QA 132 M6A	3GQA 133 301-••A	960	84.0	84.2	0.77	8.93	6.5	39.79	2.0	2.9	
5.5	M2QA 132 M6B	3GQA 133 302-••A	960	86.0	85.6	0.79	11.7	6.5	54	2.0	3.0	
7.5	M2QA 160 M6A	3GQA 163 301-••A	970	88.0	88.3	0.78	15.77	6.0	73	2.0	2.3	
11	M2QA 160 L6A	3GQA 163 501-••A	970	88.5	88.6	0.78	23	6.0	108	2.2	2.4	
15	M2QA 180 L6A	3GQA 183 501-••A	980	89.0	89.1	0.82	29.67	6.0	146	2.3	2.9	
18.5	M2QA 200 L6A	3GQA 203 501-••A	980	90.3	90.2	0.82	36.06	6.0	180	2.2	2.5	
22	M2QA 200 L6B	3GQA 203 502-••A	980	90.4	90.3	0.83	42.32	6.0	214	2.1	3.2	
30	M2QA 225 M6A	3GQA 223 301-••A	980	90.8	89.2	0.78	61	6.6	292	2.2	2.9	
37	M2QA 250 M6A	3GQA 253 301-••A	980	92.2	92.4	0.88	66	6.8	360	2.3	2.6	
45	M2BAT 280 SMA	3GBA 283 210-••D	990	93.5	93.3	0.82	85	6.7	434	2.4	2.4	
55	M2BAT 280 SMB	3GBA 283 220-••D	989	93.8	93.7	0.83	103	6.4	531	2.4	2.4	
75	²⁾ M2BAT 315 SMA	3GBA 313 210-••D	992	94.2	94.0	0.8	145	6.3	722	1.9	2.3	
90	²⁾ M2BAT 315 SMB	3GBA 313 220-••D	991	94.8	94.7	0.83	166	6.5	867	1.9	2.3	
110	²⁾ M2BAT 315 SMC	3GBA 313 230-••D	991	95.1	95.0	0.82	206	6.7	1060	2.1	2.6	
132	²⁾ M2BAT 315 MLA	3GBA 313 410-••D	991	95.3	95.2	0.83	242	6.5	1272	2.2	2.5	
160	M2BAT 355 S	3GBA 353 100-••D	992	95.3	95.2	0.83	293	6.2	1540	1.8	2.3	
1000 r/min = 6-poles			400 V 50 Hz			High-output design						
3	¹⁾ M2QA 112 M6B	3GQA 113 302-••A	950	77.0		0.76	740	6.5	30.2	1.9	2.1	
6.5	¹⁾ M2QA 132 M6C	3GQA 133 303-••A	970	83.0		0.78	14.49	6.5	64	1.9	2.1	
14	¹⁾ M2QA 160 L6B	3GQA 163 502-••A	970	85.5		0.78	30.3	6.0	138	2.1	2.2	
18.5	¹⁾ M2QA 180 L6B	3GQA 183 502-••A	980	86.0		0.82	37.87	6.0	180	2.2	2.7	
30	¹⁾ M2QA 200 L6C	3GQA 203 503-••A	980	87.4		0.78	63	6.0	292	2.0	2.6	
37	¹⁾ M2QA 225 M6B	3GQA 223 302-••A	980	87.8		0.78	78	6.6	361	2.1	2.6	
45	¹⁾ M2QA 250 M6B	3GQA 253 302-••A	980	89.2		0.88	82	6.8	439	2.2	2.6	
75	M2BAT 280 SMC	3GBA 283 230-••D	989	94.5	94.5	0.83	139	6.9	724	2.6	2.5	

¹⁾ Temperature rise class F by voltage 400 V 50 Hz.

²⁾ Temperature rise class F by voltage 380 V 50 Hz.

Missing data on request.

The two bullets in the product code indicate choice of mounting arrangement, voltage and frequency (see ordering information page).

General purpose cast iron motors

Technical data for totally enclosed squirrel cage three phase motors

IP 55 – IC 411 – Insulation class F, temperature rise class B

Output kW	Motor type	Speed r/min	Efficiency %	Power factor cos	Current I _N A	Speed r/min	Efficiency %	Power factor cos	Current I _N A	Moment of inertia J=1/4 GD ² kgm ²	Weight kg	Sound pressure level L _p dB(A)
1000 r/min = 6-poles			380 V 50 Hz			415 V 50 Hz			Basic design			
0.18	M2QA 71 M6A	905	55.5	0.69	0.72	915	52.5	0.62	0.77	0.00056	10	42
0.25	M2QA 71 M6B	885	60.0	0.65	0.98	895	59.0	0.62	0.95	0.00074	11	42
0.37	M2QA 80 M6A	925	63.5	0.7	1.29	935	62.0	0.62	1.33	0.00159	17	45
0.55	M2QA 80 M6B	920	65.0	0.71	1.82	930	65.5	0.66	1.79	0.00196	18	45
0.75	M2QA 90 S6A	915	71.0	0.75	2.13	925	70.5	0.69	2.15	0.00292	21	48
1.1	M2QA 90 L6A	915	73.0	0.77	2.98	925	73.0	0.7	2.98	0.00379	25	48
1.5	M2QA 100 L6A	935	76.0	0.79	3.8	945	75.5	0.75	3.73	0.00999	32	51
2.2	M2QA 112 M6A	935	79.0	0.77	5.5	945	80.0	0.75	5.14	0.03116	40	54
3	M2QA 132 S6A	955	82.0	0.81	6.87	965	82.5	0.76	6.66	0.03116	55	56
4	M2QA 132 M6A	955	84.0	0.77	9.39	965	84.0	0.75	8.84	0.04074	65	56
5.5	M2QA 132 M6B	945	85.5	0.8	12.3	955	86.0	0.78	11.4	0.05332	75	56
7.5	M2QA 160 M6A	968	88.0	0.79	16.39	975	88.0	0.75	15.81	0.09231	119	61
11	M2QA 160 L6A	966	88.5	0.8	23.61	975	88.5	0.75	23.06	0.1297	140	62
15	M2QA 180 L6A	980	89.0	0.84	30.48	985	89.0	0.79	29.68	0.2418	180	63
18.5	M2QA 200 L6A	975	90.6	0.84	36.94	980	90.1	0.79	36.16	0.34174	231	64
22	M2QA 200 L6B	975	90.9	0.84	43.79	980	90.1	0.81	41.93	0.46837	254	64
30	M2QA 225 M6A	980	90.5	0.78	64	980	90.9	0.76	60	0.62691	308	66
37	M2QA 250 M6A	978	92.0	0.9	68	982	92.3	0.86	64	0.97	382	68
45	M2BAT 280 SMA	988	93.9	0.83	89	990	93.5	0.8	84	1.6	540	71
55	M2BAT 280 SMB	987	93.5	0.84	108	990	93.8	0.82	101	1.9	580	71
75	²⁾ M2BAT 315 SMA	990	94.1	0.82	148	992	94.2	0.77	143	2.8	780	75
90	²⁾ M2BAT 315 SMB	990	95.7	0.84	174	992	94.8	0.81	163	3.6	870	75
110	²⁾ M2BAT 315 SMC	990	94.9	0.83	215	991	95.0	0.8	203	4.4	930	75
132	²⁾ M2BAT 315 MLA	989	95.1	0.83	255	991	95.3	0.82	237	5.3	1040	75
160	M2BAT 355 S	991	95.2	0.83	307	993	95.3	0.82	287	7.3	1500	77
1000 r/min = 6-poles			380 V 50 Hz			415 V 50 Hz			High-output design			
3	¹⁾ M2QA 112 M6B									0.0199	45	56
6.5	¹⁾ M2QA 132 M6C									0.0611	75	59
14	¹⁾ M2QA 160 L6B									0.139	155	64
18.5	¹⁾ M2QA 180 L6B									0.283984	196	65
30	¹⁾ M2QA 200 L6C									0.495	291	66
37	¹⁾ M2QA 225 M6B									0.803267	351	68
45	¹⁾ M2QA 250 M6B									1.32	455	71
75	M2BAT 280 SMC	987	94.3	0.84	144	990	94.6	0.82	135	2.6	660	71

¹⁾ Temperature rise class F by voltage 400 V 50 Hz.

²⁾ Temperature rise class F by voltage 380 V 50 Hz.

Missing data on request.

General purpose cast iron motors

Technical data for totally enclosed squirrel cage three phase motors

IP 55 – IC 411 – Insulation class F, temperature rise class B

Output kW	Motor type	Product code	Speed r/min	Efficiency		Power factor cos 100%	Current		Torque					
				Full load 100%	3/4 load 75%		I_N A	I_s A	T_N Nm	T_s Nm	T_{max} Nm			
750 r/min = 8-poles			400 V 50 Hz				Basic design							
0.18	M2QA	80 M8A	3GQA	084 301-...A	700	51.0	50.1	0.6	0.85	3.3	2.46	1.8	1.9	
0.25	M2QA	80 M8B	3GQA	084 302-...A	700	54.5	53.3	0.6	1.11	3.6	3.41	1.8	1.9	
0.37	M2QA	90 S8A	3GQA	094 101-...A	700	62.5	62.1	0.6	1.42	4.4	5.05	1.8	1.9	
0.55	M2QA	90 L8A	3GQA	094 501-...A	700	63.5	63.3	0.6	2.07	4.7	7.5	1.8	2.0	
0.75	M2QA	100 L8A	3GQA	104 501-...A	700	70.0	70.1	0.64	2.42	5.0	10.23	1.8	2.2	
1.1	M2QA	100 L8B	3GQA	104 502-...A	700	71.5	70.3	0.65	3.45	5.0	15.01	1.8	2.4	
1.5	M2QA	112 M8A	3GQA	114 301-...A	700	75.0	75.4	0.68	4.27	5.0	20.46	1.8	2.4	
2.2	M2QA	132 S8A	3GQA	134 101-...A	710	81.0	81.8	0.7	5.6	5.5	29.59	1.8	2.5	
3	M2QA	132 M8A	3GQA	134 301-...A	710	81.0	81.4	0.75	7.13	5.5	40.35	1.8	2.2	
4	M2QA	160 M8A	3GQA	164 301-...A	720	84.0	84.0	0.73	9.42	5.5	53	2.1	2.6	
5.5	M2QA	160 M8B	3GQA	164 302-...A	720	85.5	85.6	0.74	12.55	5.5	72	2.1	2.8	
7.5	M2QA	160 L8A	3GQA	164 501-...A	720	86.5	85.8	0.74	16.91	5.5	99	2.1	2.5	
11	M2QA	180 L8A	3GQA	184 501-...A	730	87.7	87.0	0.77	23.51	5.4	143	2.0	2.8	
15	M2QA	200 L8A	3GQA	204 501-...A	730	89.0	89.4	0.76	32.009	5.5	196	2.3	2.8	
18.5	M2QA	225 S8A	3GQA	224 101-...A	740	90.0	89.1	0.75	39.56	5.5	238	2.1	2.7	
22	M2QA	225 M8A	3GQA	224 301-...A	740	90.5	88.2	0.75	46.78	6.0	283	2.2	2.7	
30	M2QA	250 M8A	3GQA	254 301-...A	740	91.3	90.1	0.79	60	6.5	387	2.3	2.4	
37	M2BAT	280 SMA	3GBA	284 210-...D	741	93.5	93.3	0.78	74	7.3	477	1.8	3.0	
45	M2BAT	280 SMB	3GBA	284 220-...D	741	94.0	93.8	0.78	90	7.6	580	1.9	3.2	
55	M2BAT	315 SMA	3GBA	314 210-...D	742	94.1	94.0	0.81	104	7.1	708	1.6	2.7	
75	M2BAT	315 SMB	3GBA	314 220-...D	741	94.4	94.3	0.82	141	7.1	968	1.7	2.7	
90	M2BAT	315 SMC	3GBA	314 230-...D	741	94.8	94.7	0.82	167	7.4	1161	1.8	2.7	
110	M2BAT	315 MLA	3GBA	314 410-...D	740	95.0	95.0	0.83	203	7.3	1420	1.8	2.7	
132	M2BAT	355 S	3GBA	354 100-...D	743	95.0	94.9	0.81	247	6.5	1697	1.3	2.3	
750 r/min = 8-poles			400 V 50 Hz				High-output design							
2	¹⁾ M2QA	112 M8B	3GQA	114 302-...A	700	72.0		0.68	5.94	5.2	27.3	1.7	1.9	
3.8	¹⁾ M2QA	132 M8B	3GQA	134 302-...A	710	78.0		0.75	9.38	5.5	51	1.7	1.9	
8.5	¹⁾ M2QA	160 L8B	3GQA	164 502-...A	720	83.5		0.74	19.86	5.5	113	2.0	2.4	
15	¹⁾ M2QA	180 L8B	3GQA	184 502-...A	730	84.7		0.77	33.2	5.4	196	1.9	2.6	
18.5	¹⁾ M2QA	200 L8B	3GQA	204 502-...A	730	86.0		0.76	40.85	5.4	242	1.9	2.6	
30	¹⁾ M2QA	225 M8B	3GQA	224 302-...A	740	87.5		0.75	66	6.3	387	2.1	2.6	
37	¹⁾ M2QA	250 M8B	3GQA	254 302-...A	740	88.3		0.79	76	6.5	478	2.2	2.5	
55		M2BAT	280 SMC	3GBA	284 230-...D	741	94.4	94.3	0.79	108	7.8	709	1.9	3.2

¹⁾ Temperature rise class F by voltage 400 V 50 Hz.

²⁾ Temperature rise class F by voltage 380 V 50 Hz.

Missing data on request.

The two bullets in the product code indicate choice of mounting arrangement, voltage and frequency (see ordering information page).

General purpose cast iron motors

Technical data for totally enclosed squirrel cage three phase motors

IP 55 – IC 411 – Insulation class F, temperature rise class B

Output kW	Motor type	Speed r/min	Efficiency %	Power factor cos	Current I _N A	Speed r/min	Efficiency %	Power factor cos	Current I _N A	Moment of inertia J=1/4 GD ² kgm ²	Weight kg	Sound pressure level L _p dB(A)
750 r/min = 8-poles		380 V 50 Hz			415 V 50 Hz			Basic design				
0.18	M2QA 80 M8A	695	51.0	0.61	0.88	705	51.5	0.6	0.82	0.00111	16	42
0.25	M2QA 80 M8B	695	54.0	0.61	1.16	705	54.5	0.6	1.08	0.00326	17	42
0.37	M2QA 90 S8A	695	62.0	0.61	1.49	705	62.5	0.6	1.38	0.00541	21	46
0.55	M2QA 90 L8A	695	63.0	0.61	2.18	705	63.5	0.6	2.01	0.00756	24	46
0.75	M2QA 100 L8A	695	70.0	0.67	2.43	705	69.0	0.64	2.39	0.00971	31	53
1.1	M2QA 100 L8B	695	71.5	0.68	3.45	705	70.5	0.62	3.47	0.01186	34	53
1.5	M2QA 112 M8A	695	75.0	0.68	4.47	705	75.0	0.67	4.16	0.01559	42	55
2.2	M2QA 132 S8A	705	80.5	0.75	5.6	715	80.5	0.69	5.55	0.03625	56	55
3	M2QA 132 M8A	705	81.0	0.78	7.22	715	81.0	0.72	7.11	0.04141	64	56
4	M2QA 160 M8A	715	84.0	0.76	9.52	720	84.0	0.7	9.46	0.0676	105	58
5.5	M2QA 160 M8B	715	85.5	0.76	12.86	720	85.5	0.7	12.78	0.09524	125	58
7.5	M2QA 160 L8A	715	86.5	0.77	17.11	722	86.5	0.7	17.23	0.12122	142	58
11	M2QA 180 L8A	725	87.7	0.79	24.12	730	87.7	0.74	23.58	0.23645	176	61
15	M2QA 200 L8A	725	88.9	0.78	32.86	730	88.8	0.74	31.75	0.37103	235	63
18.5	M2QA 225 S8A	740	89.9	0.75	41.69	745	90.3	0.71	40.14	0.53287	290	65
22	M2QA 225 M8A	740	90.4	0.76	48.65	745	90.3	0.71	47.74	0.65825	302	65
30	M2QA 250 M8A	738	91.1	0.8	63	741	91.4	0.78	58	0.975	392	67
37	M2BAT 280 SMA	740	93.2	0.8	75	742	93.4	0.76	73	1.85	570	65
45	M2BAT 280 SMB	740	93.8	0.8	92	742	94.0	0.75	90	2.2	610	65
55	M2BAT 315 SMA	741	93.9	0.83	108	743	94.1	0.79	103	3.2	820	65
75	M2BAT 315 SMB	740	94.2	0.83	147	742	94.4	0.81	137	4.1	910	65
90	M2BAT 315 SMC	740	94.6	0.84	173	742	94.8	0.81	164	4.9	980	65
110	M2BAT 315 MLA	739	94.9	0.84	210	741	95.0	0.81	198	5.8	1100	72
132	M2BAT 355 S	742	94.9	0.82	258	743	95.0	0.8	244	7.3	1500	75
750 r/min = 8-poles		380 V 50 Hz			415 V 50 Hz			High-output design				
2	¹⁾ M2QA 112 M8B									0.0199	45	58
3.8	¹⁾ M2QA 132 M8B									0.04776	75	59
8.5	¹⁾ M2QA 160 L8B									0.1312	136	61
15	¹⁾ M2QA 180 L8B									0.283984	196	63
18.5	¹⁾ M2QA 200 L8B									0.46854	274	65
30	¹⁾ M2QA 225 M8B									0.803267	349	67
37	¹⁾ M2QA 250 M8B									1.28	436	69
55	M2BAT 280 SMC	740	94.2	0.81	110	742	94.4	0.77	106	2.85	690	65

¹⁾ Temperature rise class F by voltage 400 V 50 Hz.

²⁾ Temperature rise class F by voltage 380 V 50 Hz.

Missing data on request.

General purpose cast iron motors - Variant codes

Code	Variant	Motor size					
		71-80	90-100	112-132	160-180	200-250	280-355
1)							
Balancing							
052	Vibration acc. to Grade A (IEC 60034-14).	M	M	M	NA	NA	NA
424	Vibration acc. to Grade B (IEC 60034-14).	M	M	M	R	R	NA
417	Full key balancing.	M	M	M	R	R	NA
Bearings and lubrication							
036	Transport lock for bearings.	NA	NA	NA	M	M	M
037	Roller bearing at D-end.	NA	NA	NA	M	M	M
039	Cold resistant grease.	M	M	M	M	M	M
040	Heat resistant grease.	M	M	M	M	M	M
041	Bearings regreasable via grease nipples. Frame size 250 as standard.	NA	NA	NA	M	M	S
043	SPM-nipples. Frame size 355 as standard.	NA	NA	M	NA	NA	M
Branch standard designs							
178	Stainless steel/acid proof bolts.	M	M	M	M	M	M
209	Non-standard voltage or frequency, (special winding).	M	M	M	M	M	NA
425	Corrosion protected stator and rotor core.	M	M	M	M	M	S
785	Reinforced tropicalisation.	S	S	S	S	S	S
Cooling system							
068	Metal fan.	M	M	M	M	M	M
183	Separate motor cooling fan (fan axial, N-end).	P	M	M	P	P	NA
Dimension drawing							
141	Binding dimension drawing.	M	M	M	M	M	M
Drain holes							
065	Plugged existing drain holes.	NA	NA	NA	NA	NA	M
066	Modified drain hole position (for specified IM xxxx).	NA	NA	NA	NA	NA	M
076	Draining holes with plugs.	M	M	M	M	M	S
Earthing bolt							
067	External earthing bolt.	M	M	M	M	M	M
Heating elements							
	Motor size	Element capacity					
	71-160	25 W					
	180-280	50 W					
	315	1 x 65 W					
	355	2 x 65 W					
450	Heating element, 100-120 V.	M	M	M	M	M	M
451	Heating element, 200-240 V.	M	M	M	M	M	M
Insulation system							
014	Winding insulation class H.	P	P	P	P	P	NA
405	Special winding insulation for frequency converter supply.	P	P	P	P	P	NA

*) Certain variant codes cannot be used simultaneously.

S = Included as standard

M = On modification of a stocked motor, or on new manufacture, the number per order may be limited.

P = New manufacture only.

R = On request.

NA = Not applicable

Code	Variant	Motor size					
		71-80	90-100	112-132	160-180	200-250	280-355
1)							
Mounting arrangements							
008	IM2101 foot/flange mounted, IEC flange, from IM1001(B34 from B3). Not possible for frame size 132.	M	M	M	NA	NA	NA
009	IM2001 foot/flange mounted, IEC flange, from IM1001(B35 from B3).	M	M	M	M	M	M
047	IM 3601 flange mounted, IEC flange, from IM3001 (B14 from B5). Not possible for frame size 132.	M	M	M	NA	NA	NA
078	(IM 3601) flange mounted, DIN C-flange. Larger flange than standard version. Not possible for frame size 132.	M	M	M	NA	NA	NA
090	(IM 2101) foot/flange mounted, DIN C-flange, from IM 1001 (B34 from B3). Not possible for frame size 132.	M	M	M	NA	NA	NA
Painting							
114	Special paint colour, standard grade.	M	M	M	M	M	M
Protection							
005	Protective roof, vertical motor, shaft down.	M	M	M	M	M	M
072	Radial seal at D-end.	M	M	M	M	M	M
073	Sealed against oil at D-end.	P	P	P	P	P	M
158	Degree of protection IP65.	M	M	M	M	M	NA
211	Weather protected, IP xx W.	M	M	M	M	M	NA
401	Protective roof, horizontal motor.	M	M	M	M	M	M
403	Degree of protection IP56.	M	M	M	M	M	NA
Rating & instruction plates							
002	Restamping voltage, frequency and output, continuous duty.	M	M	M	M	M	M
095	Restamping output (maintained voltage, frequency) intermittent duty.	M	M	M	M	M	M
135	Mounting of additional identification plate, stainless.	M	M	M	M	M	M
138	Mounting of additional identification plate, aluminum.	M	M	M	M	M	M
139	Additional identification plate delivered loose.	M	M	M	M	M	M
161	Additional rating plate delivered loose.	M	M	M	M	M	M
Stator winding temperature sensors							
121	Bimetal detectors, break type (NCC), (3 in series), 130°C, in stator winding.	M	M	M	M	M	M
122	Bimetal detectors, break type (NCC), (3 in series), 150°C, in stator winding.	M	M	M	M	M	M
123	Bimetal detectors, break type (NCC), (3 in series), 170°C, in stator winding.	M	M	M	M	M	M
125	Bimetal detectors, break type (NCC), (2x3 in series), 150°C, in stator winding.	M	M	M	M	M	M
127	Bimetal detectors, break type (NCC), (3 in series, 130°C, & 3 in series, 150°C), in stator winding.	M	M	M	M	M	M
321	Bimetal detectors, closing type (NO), (3 in parallel), 130°C, in stator winding.	M	M	M	M	M	M
322	Bimetal detectors, closing type (NO), (3 in parallel), 150°C, in stator winding.	M	M	M	M	M	M
323	Bimetal detectors, closing type (NO), (3 in parallel), 170°C, in stator winding.	M	M	M	M	M	M
325	Bimetal detectors, closing type (NO), (2x3 in parallel), 150°C, in stator winding.	M	M	M	M	M	M
327	Bimetal detectors, closing type (NO), (3 in parallel, 130°C, & 3 in parallel 150°C), in stator winding.	M	M	M	M	M	M

*) Certain variant codes cannot be used simultaneously.

S = Included as standard
M = On modification of a stocked motor, or on new manufacture, the number per order may be limited.

P = New manufacture only.
R = On request.
NA = Not applicable

Code	Variant	Motor size					
		71-80	90-100	112-132	160-180	200-250	280-355
1)							
435	PTC-thermistors (3 in series), 130°C, in stator winding.	M	M	M	M	M	M
436	PTC-thermistors (3 in series), 150°C, in stator winding.	M	M	M	S	S	S
437	PTC-thermistors (3 in series), 170°C, in stator winding.	M	M	M	M	M	M
439	PTC-thermistors (2x3 in series), 150°C, in stator winding.	M	M	M	M	M	M
441	PTC-thermistors (3 in series 150°C & 3 in series 150°C, in stator winding.	M	M	M	M	M	M
442	PTC-thermistors (3 in series 150°C & 3 in series 150°C, in stator winding.	M	M	M	M	M	M
445	Pt100 (1per phase) in stator winding. Not available for frame size 71.	M	M	M	M	M	M

Terminal box

015	Motor supplied in D-connection.	M	M	M	M	M	M
017	Motor supplied in Y-connection.	M	M	M	M	M	M
021	Terminal box LHS, seen from D-end (= L in product code).	P	P	P	P	P	NA
137	Extended cable connection, low terminal box.	P	P	P	P	P	NA
157	Terminal box degree of protection IP 65.	M	M	M	M	M	M
180	Terminal box RHS, seen from D-end (= R in product code).	M	M	M	M	M	NA
230	One standard cable gland or cable box.	M	M	M	M	M	S
231	Standard cable glands with clamping device.	S	S	S	M	M	NA
400	4x90 degrees turnable terminal box.	P	P	P	P	P	NA
418	Separate terminal box for temperature detectors.	M	M	M	P	P	M
467	Lower than standard terminal box and rubber extended cable, length 2 m included.	M	M	M	M	M	M
468	Cable entry from D-end.	M	M	M	M	M	M
469	Cable entry from N-end.	M	M	M	NA	NA	NA
731	Two standard cable glands.	NA	NA	NA	NA	NA	M

Testing

145	Type test report from catalogue motor, 400 V 50 Hz.	M	M	M	M	M	M
146	Type test with report for motor from specific delivery batch.	R	R	R	R	R	M
148	Routine test report.	M	M	M	M	M	M
760	Vibration level test.	M	M	M	M	M	M
762	Noise level test.	NA	NA	NA	NA	NA	M

Variable speed drives

701	Insulated bearing at N-end.	NA	NA	NA	NA	NA	M
704	EMC cable gland.	NA	NA	NA	NA	NA	M

*) Certain variant codes cannot be used simultaneously.

S = Included as standard

M = On modification of a stocked motor, or on new manufacture, the number per order may be limited.

P = New manufacture only.

R = On request.

NA = Not applicable

General purpose cast iron motors

Sizes 71-132

Dimension drawings

Foot-mounted; IM B3 (IM 1001), IM B6 (IM 1011), IM B7 (IM 1061), IM B8 (IM 1071), IM V5 (IM 1011), IM V6 (IM 1031)

Three phase motor, foot-mounted, terminal box top-mounted

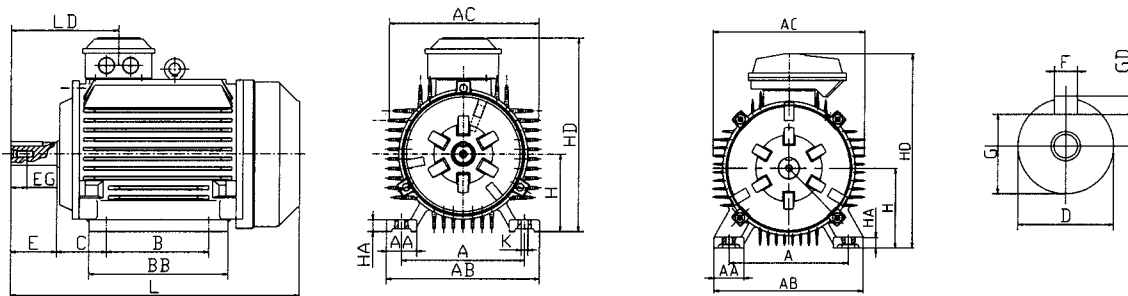

Three phase motor, foot-mounted, terminal box on right hand side

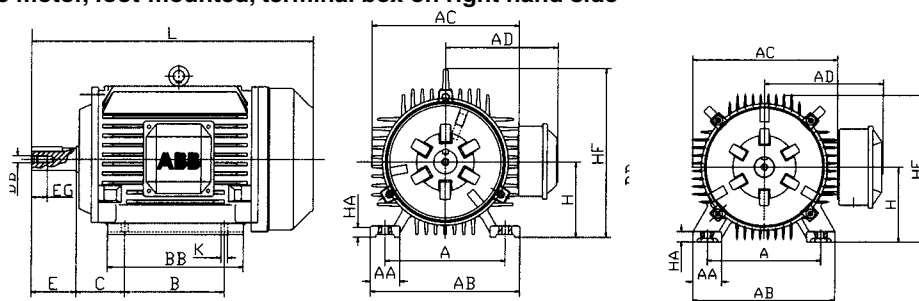

4

Motor size	Poles	A	AA	AB	AC	AD	B	BB	C	D	DB	E	EG
71M	2-6	112	30	145	145	120	90	110	45	14	M5	30	12.5
80M	2-6	125	35	160	165	145	100	135	50	19	M6	40	16
90S	2-6	140	35	175	180	150	100	140	56	24	M8	50	19
90L	2-6	140	35	175	180	150	125	165	56	24	M8	50	19
100L	2-6	160	40	200	205	175	140	180	63	28	M10	60	22
112M	2-8	190	50	235	225	185	140	190	70	28	M10	60	22
132S	2-8	216	55	270	265	205	140	205	89	38	M12	80	28
132M	2-8	216	55	270	265	205	178	240	89	38	M12	80	28

Motor size	Poles	F	G	GD	H	HA	HD	HF	K	L	LD
71 M	2-6	5	11	5	71	10	200	-	7	255	100
80 M	2-6	6	15.5	6	80	12	225	170	10	285	116
90 S	2-6	8	20	7	90	12	240	185	10	310	128
90 L	2-6	8	20	7	90	12	240	185	10	335	128
100 L	2-6	8	24	7	100	14	275	245	12	380	144
112 M	2-6	8	24	7	112	15	290	265	12	380	144
132 S	2-6	10	33	8	132	18	335	300	12	465	169
132 M	2-6	10	33	8	132	18	335	300	12	505	169

Tolerances:

A, B, C	+ , - 0.8	H	+ 0, - 0.5
D, DA	ISO m6	N	ISO j6
F, FA	ISO h9		

Above table gives the main dimensions in mm.

For detailed drawings please see our web-pages 'www.abb.com/motors&drives' or contact us.

General purpose cast iron motors

Sizes 71-132

Dimension drawings

Flange-mounted; IM B5 (IM 3001), IM V1 (IM 3001), IM V3 (IM 3031)
IM B14 (IM 3601), IM V18 (IM 3611), IM V19 (IM 3631)

Three phase motor, flange-mounted

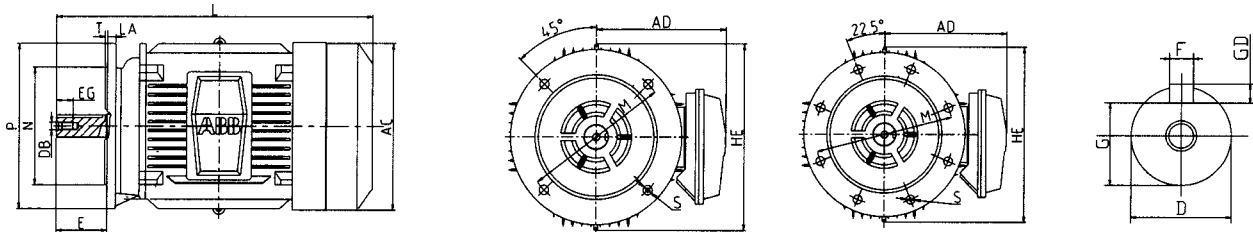

Three phase motor, flange-mounted, small flange (B14)

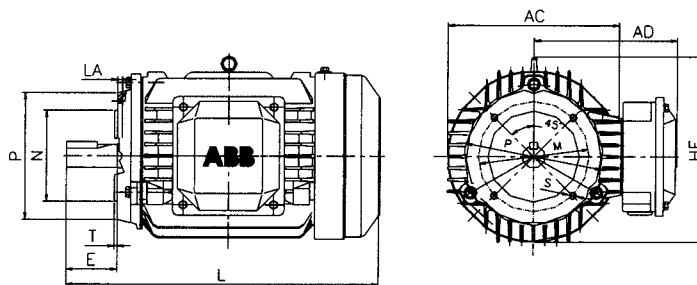

IM B5 (IM3001), IM V1 (IM3011), IM V3 (IM3031)

Type	Poles	AC	AD	D	DB	E	EG	F	G	GD	HE	L	LA	M	N	P	S	T
M2QA																		
71M	2-6	145	120	14	M5	30	12.5	5	11	5	165	255	9	130	110	160	10	3.5
80M	2-8	165	145	19	M6	40	16	6	15.5	6	200	285	9	165	130	200	12	3.5
90S	2-8	180	150	24	M8	50	19	8	20	7	200	310	10	165	130	200	12	3.5
90L	2-8	180	150	24	M8	50	19	8	20	7	200	335	10	165	130	200	12	3.5
100L	2-8	205	175	28	M10	60	22	8	24	7	265	380	11	215	180	250	15	4
112M	2-8	225	185	28	M10	60	22	8	24	7	270	395	11	215	180	250	15	4
132S	2-8	265	205	38	M12	80	28	10	33	8	320	465	12	265	230	300	15	4
132M	2-8	265	205	38	M12	80	28	10	33	8	320	505	12	265	230	300	15	4

IM B14 (IM3611), IM V19 (IM3631)

Motor size	Poles	Flange size	HE	P	M	N	S	T
71M	2-6	C105	145	105	85	70	M6	2.5
		C140	145	140	95	M8	3	
80M	2-8	C120	165	120	100	80	M6	3
		C160	165	160	130	110	M8	3.5
90S	2-8	C140	185	140	115	95	M8	3
		C160	185	160	130	110	M8	3.5
90L	2-8	C140	185	140	115	95	M8	3
		C160	185	160	130	110	M8	3.5
100L	2-8	C160	255	160	130	110	M8	3.5
		C200	255	200	165	130	M10	3.5
112M	2-8	C160	265	160	130	110	M8	3.5
		C200	265	200	165	130	M10	3.5

Tolerances:

D, DA ISO m6
F, FA ISO h9
N ISO j6

Above table gives the main dimensions in mm.

For detailed drawings please see our web-pages 'www.abb.com/motors&drives' or contact us.

General purpose cast iron motors

Sizes 71-132

Dimension drawings

Foot- and flange-mounted; M B35 (IM 2001), IM V15 (IM 2011), IM V 36 (IM 2031)

Three phase motor, foot- and flange-mounted, terminal box top-mounted

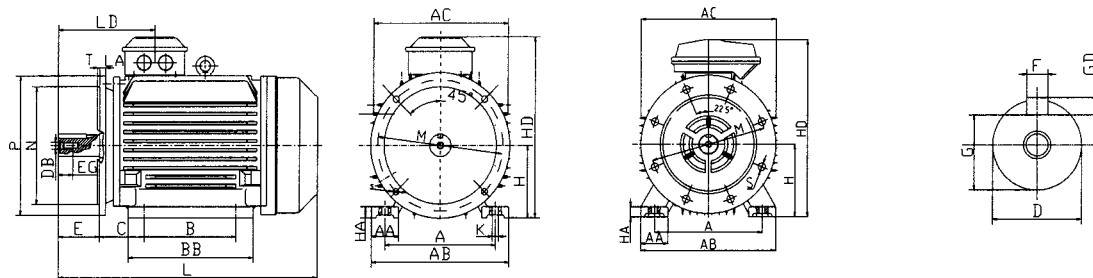

Three phase motor, foot- and flange-mounted, terminal box on right

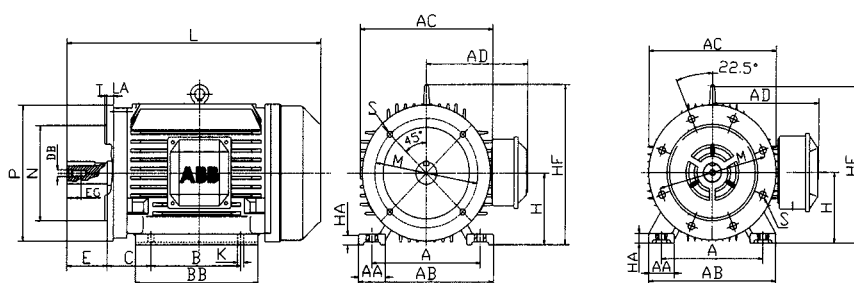

4

Motor size	Poles	A	AA	AB	AC	AD	B	BB	C	D	DB	E	EG	F
71M	2-6	112	30	145	145	120	90	110	45	14	M5	30	12.5	5
80M	2-8	125	35	160	165	145	100	135	50	19	M6	40	16	6
90S	2-8	140	35	175	180	150	100	140	56	24	M8	50	19	8
90L	2-8	140	35	175	180	150	125	165	56	24	M8	50	19	8
100L	2-8	160	40	200	205	175	140	180	63	28	M10	60	22	8
112M	2-8	190	50	235	225	185	140	190	70	28	M10	60	22	8
132S	2-8	216	55	270	265	205	140	205	89	38	M12	80	28	10
132M	2-8	216	55	270	265	205	178	240	89	38	M12	80	28	10

Motor size	Poles	G	GD	H	HA	HD	HF	K	L	LA	LD	M	N	P	S	T
71M	2-6	11	5	71	10	200	-	7	255	9	100	130	110	160	10	3.5
80M	2-8	15.5	6	80	12	225	170	10	285	9	116	165	130	200	12	3.5
90S	2-8	20	7	90	12	240	185	10	310	10	128	165	130	200	12	3.5
90L	2-8	20	7	90	12	240	185	10	335	10	128	165	130	200	12	3.5
100L	2-8	24	7	100	14	275	245	12	380	11	138	215	180	250	15	4
112M	2-8	24	7	112	15	290	265	12	395	11	144	215	180	250	15	4
132S	2-8	33	8	132	18	335	300	12	465	12	169	265	230	300	15	4
132M	4-8	33	8	132	18	335	300	12	505	12	169	265	230	300	15	4

Tolerances:

A, B, C	+/- 0.8	H	+ 0, -0.5
D, DA	ISO m6	N	ISO j6
F, FA	ISO h9		

Above table gives the main dimensions in mm.
For detailed drawings please see our web-pages 'www.abb.com/motors&drives' or contact us.

General purpose cast iron motors

Sizes 160-250

Dimension drawings

Foot-mounted; IM B3 (IM 1001), IM B6 (IM 1051), IM B7 (IM 1061), IM B8 (IM 1071), IM V5 (IM 1011), IM V6 (IM 1031)

Three phase motor, foot-mounted, terminal box top-mounted

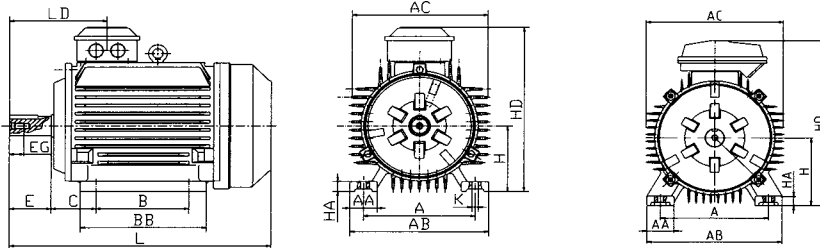

Three phase motor, foot-mounted, terminal box on right hand side

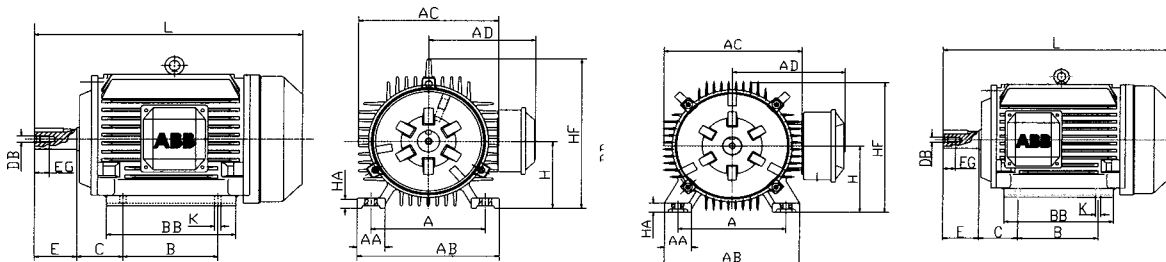

IEC-frame size 250

Motor size	Poles	A	AA	AB	AC	AD	B	BB	C	D	DB	E	EG
160 M	2-8	254	60	325	330	255	210	265	108	42	M16	110	36
160 L	2-8	254	60	325	330	255	254	310	108	42	M16	110	36
180 M	2-4	279	70	350	355	270	241	315	121	48	M16	110	36
180 L	4-8	279	70	350	350	270	279	350	121	48	M16	110	36
200 L	2-8	318	70	390	395	305	305	380	133	55	M20	110	39
225 S	4-8	356	75	435	440	335	286	380	149	60	M20	140	39
225 M	2	356	75	435	450	335	311	405	149	55	M20	110	39
225 M	4-8	356	75	435	450	335	311	405	149	60	M20	140	39
250 M	2	406	80	490	515	395	349	455	168	60	M20	140	39
250 M	4-8	406	80	490	515	395	439	455	168	65	M20	140	39

Motor size	Poles	F	G	GD	H	HA	HD	HF	K	L	LD
160 M	2-8	12	47	8	160	22	415	380	15	600	250
160 L	2-8	12	47	8	160	22	415	380	15	645	250
180 M	2-4	14	42.5	9	180	22	450	420	15	670	270
180 L	4-8	14	42.5	9	180	22	450	420	15	710	270
200 L	2-8	16	49	10	200	25	510	470	19	770	285
225 S	4-8	18	53	11	225	28	560	520	19	820	340
225 M	2	16	49	10	225	28	560	520	19	815	310
225 M	4-8	18	53	11	225	28	560	520	19	840	340
250 M	2	18	53	11	250	30	645	580	24	930	360
250 M	4-8	18	58	11	250	30	645	580	24	930	360

Tolerances:

A, B, C	+ , - 0.8	F, FA	ISO h0
D, DA	ISO k6 < Ø 50 mm	H	+ 0, - 0.5
	ISO h9 > Ø 50 mm		

Above table gives the main dimensions in mm.

For detailed drawings please see our web-pages 'www.abb.com/motors&drives' or contact us.

General purpose cast iron motors

Sizes 160-250

Dimension drawings

Flange-mounted; IM B5 (IM 3001), IM V1 (IM 3011), IM V3 (IM 3031),
IM B14 (IM 3601), IM V18 (IM 3611), IM V19 (IM 3631)

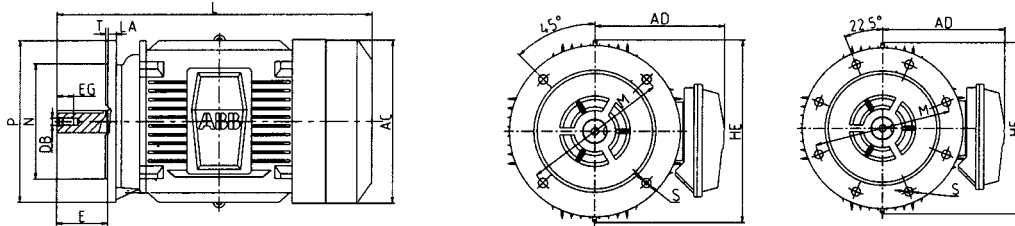

4

Motor size	Poles	AD	D	DB	E	EG	F	G	GD	HE	L	LA	M	N	P	S	T
160 M	2-8	255	42	M16	110	36	12	47	8	400	600	15	300	250	350	19	5
160 L	2-8	255	42	M16	110	36	12	47	8	400	645	15	300	250	350	19	5
180 M	2-4	270	48	M16	110	36	14	42.5	9	420	670	18	300	250	350	19	5
180 L	4-8	270	48	M16	110	36	14	42.5	9	420	710	18	300	250	350	19	5
200 L	2-8	305	55	M20	110	39	16	49	10	470	770	20	350	300	400	19	5
225 S	4-8	335	60	M20	140	39	18	53	11	520	820	20	400	350	450	19	5
225 M	2	335	55	M20	110	39	16	49	10	520	815	20	400	350	450	19	5
225 M	4-8	335	60	M20	140	39	18	53	11	520	840	20	400	350	450	19	5
250 M	2	395	60	M20	140	39	18	53	11	655	930	22	500	450	550	19	5
250 M	4-8	395	65	M20	140	39	18	53	11	655	930	22	500	450	550	19	5

Tolerances:

D, DA	ISO k6 < Ø 50 mm
	ISO m6 > Ø 50 mm
F, FA	ISO h9
N	ISO j6

Above table gives the main dimensions in mm.

For detailed drawings please see our web-pages
'www.abb.com/motors&drives' or contact us.

General purpose cast iron motors

Sizes 160-250

Dimension drawings

Foot- and flange-mounted; IM B35 (IM 2001), IM V15 (IM 2011), IM V36 (IM 2031)

Three phase motor, foot-mounted, terminal box top-mounted

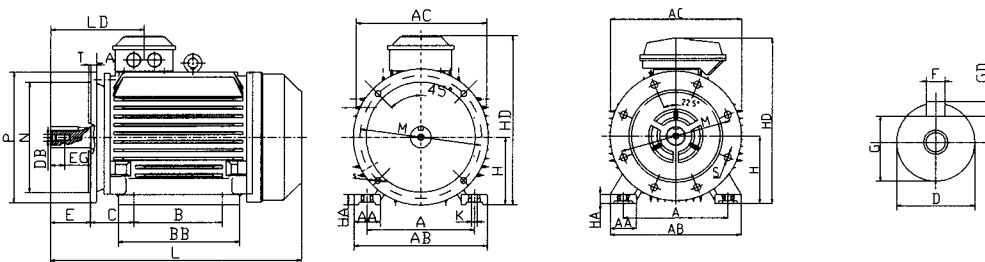

Three phase motor, foot-mounted, terminal box on right hand side

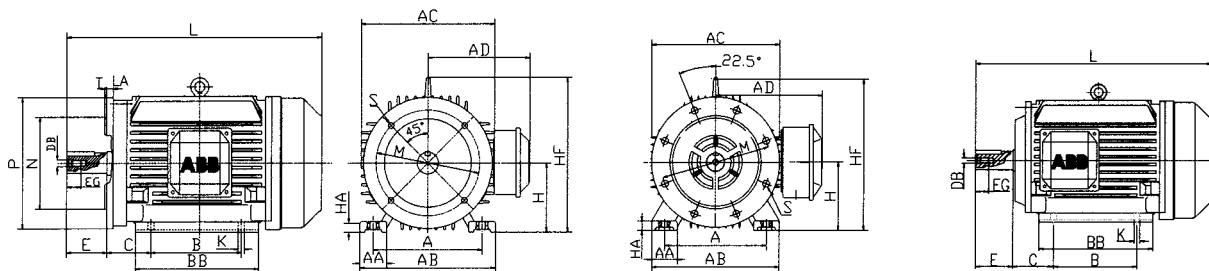

IEC frame size 250

Motor size	Poles	A	AA	AB	AC	AD	B	BB	C	D	DB	E	EG	F	G
160 M	2-8	254	60	325	330	255	210	265	108	42	M16	110	36	12	47
160 L	2-8	254	60	325	330	255	254	310	108	42	M16	110	36	12	47
180 M	2-4	279	70	350	355	270	241	315	121	48	M16	110	36	14	42.5
180 L	4-8	279	70	350	350	270	279	350	121	48	M16	110	36	14	42.5
200 L	2-8	318	70	390	395	305	305	380	133	55	M20	110	39	16	49
225 S	4-8	356	75	435	440	335	286	380	149	60	M20	140	39	18	53
225 M	2	356	75	435	450	335	311	405	149	55	M20	110	39	18	49
225 M	4-8	356	75	435	450	335	311	405	149	60	M20	140	39	18	53
250 M	2	406	80	490	515	395	349	455	168	60	M20	140	39	18	53
250 M	4-8	406	80	490	515	395	439	455	168	65	M20	140	39	18	53

Motor size	Poles	GD	H	HA	HD	HF	K	L	LA	LD	M	N	P	S	T
160 M	2-8	8	160	22	415	380	15	600	15	250	300	250	350	19	5
160 L	2-8	8	160	22	415	380	15	645	15	250	300	250	350	19	5
180 M	2-4	9	180	22	450	420	15	670	18	270	300	250	350	19	5
180 L	4-8	9	180	22	450	420	15	710	18	270	300	250	350	19	5
200 L	2-8	10	200	25	510	470	19	770	20	285	350	300	400	19	5
225 S	4-8	11	225	28	560	520	19	820	20	340	400	350	450	19	5
225 M	2	10	225	28	560	520	19	815	20	310	400	350	450	19	5
225 M	4-8	11	225	28	560	520	19	840	20	340	400	350	450	19	5
250 M	2	11	250	30	645	580	24	930	22	360	500	450	550	19	5
250 M	4-8	11	250	30	645	580	24	930	22	360	500	450	550	19	5

Tolerances:

A, B, C	+, - 0.8	F, FA	ISO h9
D, DA	ISO k6 > Ø 50 mm	H	+ 0, - 0.5
	ISO m6 > Ø 50 mm	N	ISO j6

Above table gives the main dimensions in mm.

For detailed drawings please see our web-pages www.abb.com/motors&drives or contact us.

General purpose cast iron motors

Sizes 280-315

Dimension drawings

Foot-mounted; IM B3 (IM 1001), IM B6 (IM 1051), IM B7 (IM 1061), IM B8 (IM 1071), IM V5 (IM 1011), IM V6 (IM 1031)

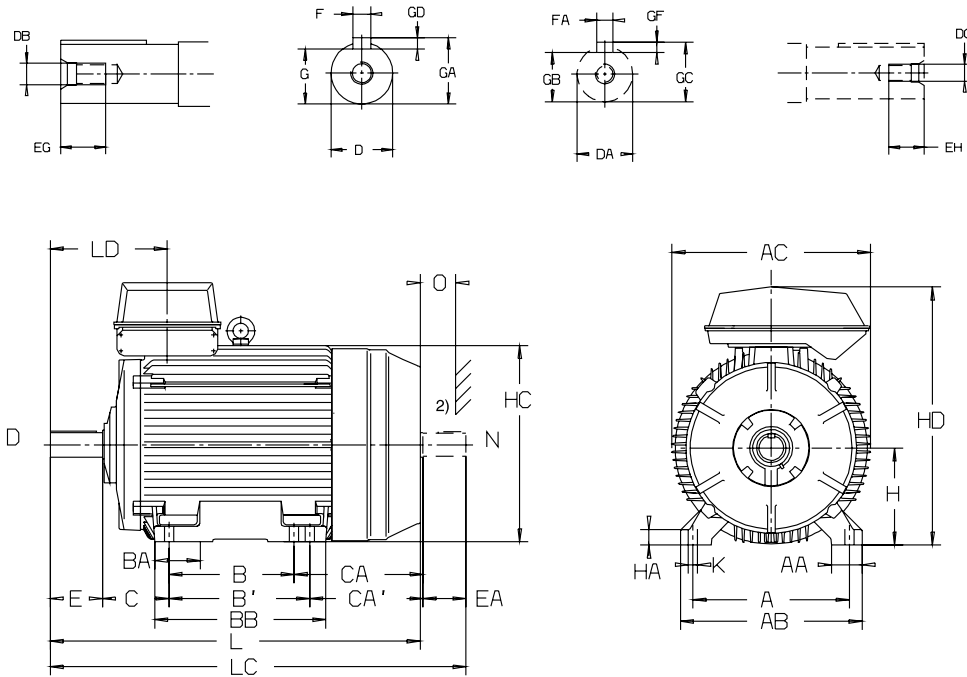

Motor size	Poles	A	AA	AB	AC	B	B'	BA	BB	C	CA	CA'	D	DA	DB	DC	E	EA	EG	EH
280 SM ₂	2	457	85	530	572	368	419	146	506	190	400	349	65	60	M20	M20	140	140	40	40
	4-12	457	85	530	572	368	419	146	506	190	400	349	75	65	M20	M20	140	140	40	40
315 SM ₂	2	508	100	590	645	406	457	163	556	216	465	414	65	60	M20	M20	140	140	40	40
	4-12	508	100	590	645	406	457	163	556	216	465	414	80	75	M20	M20	170	140	40	40
315 ML ₂	2	508	100	590	645	457	508	163	607	216	465	414	65	60	M20	M20	140	140	40	40
	4-12	508	100	590	645	457	508	163	607	216	465	414	90	75	M24	M20	170	140	48	40
355 ₂	2	610	120	700	740	500	-	161	662	254	460	-	70	70	M20	M20	140	140	40	40
	4-12	610	120	700	740	500	-	161	662	254	460	-	100	90	M24	M24	210	170	48	48

Motor size	Poles	F	FA	G	GA	GB	GC	GD	GF	H	HA	HC	HD	K	L	LA	LC	LD	O ¹⁾
280 SM ₂	2	18	18	58	69	53	64	11	11	280	40	566	745	24	1088	22	1238	332	100
	4-12	20	18	67.5	79.5	58	69	12	11	280	40	566	745	24	1088	22	1238	332	100
315 SM ₂	2	18	18	58	69	53	64	11	11	315	50	638	840	30	1218	25	1367	351	115
	4-12	22	20	71	85	67.5	79.5	14	12	315	50	638	840	30	1248	25	1397	381	115
315 ML ₂	2	18	18	58	69	53	64	11	11	315	50	638	840	30	1269	25	1418	351	115
	4-12	25	20	84	95	67.5	79.5	14	12	315	50	638	840	30	1299	25	1448	381	115
355 S ₂	2	20	20	62.5	74.5	62.5	74.5	12	12	355	55	725	955	35	1344	25	1494	397	130
	4-12	28	25	90	106	81	95	16	14	355	55	725	955	35	1414	25	1594	467	130

Tolerances:

D, DA ISO M6
H +0, -1.0

¹⁾ Cooling distance.

²⁾ Second shaft end on request.

Above table gives the main dimensions in mm.

For detailed drawings please see our web-pages
'www.abb.com/motors&drives' or contact us.

General purpose cast iron motors

Sizes 280-355

Dimension drawings

Flange-mounted; IM B5 (IM 3001), IM V1 (IM 3001), IM V3 (IM 3031)
IM B14 (IM 3601), IM V18 (IM 3611), IM V19 (IM 3631)

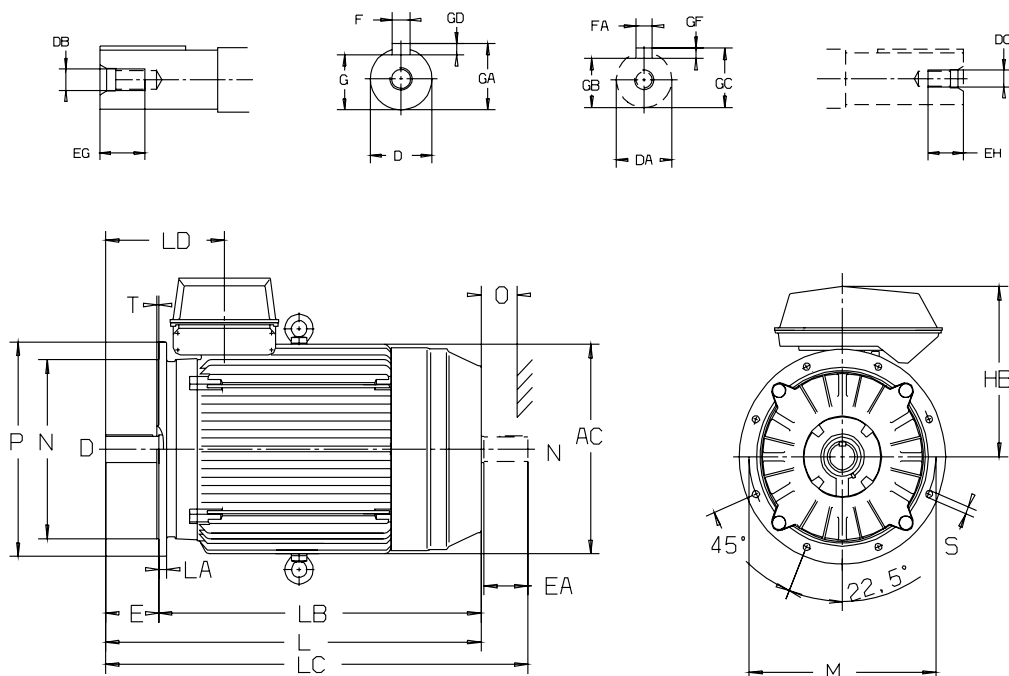

Motor size	Poles	AC	D	DA	DB	DC	E	EA	EG	EH	F	FA	G	GA	GB	GC	GD	GF
280 SM ₋	2	572	65	60	M20	M20	140	140	40	40	18	18	58	69	53	64	11	11
	4-12	572	75	65	M20	M20	140	140	40	40	20	18	67.5	79.5	58	69	12	11
315 SM ₋	2	645	65	60	M20	M20	140	140	40	40	18	18	58	69	53	64	11	11
	4-12	645	80	75	M20	M20	170	140	40	40	22	20	71	85	67.5	79.5	14	12
315 ML ₋	2	645	65	60	M20	M20	140	140	40	40	18	18	58	69	53	64	11	11
	4-12	645	90	75	M24	M20	170	140	48	40	25	20	81	95	67.5	79.5	14	12
355 S ₋	2	746	70	70	M20	M20	140	140	40	40	20	20	62.5	74.5	62.5	74.5	12	12
	4-12	645	100	90	M24	M24	210	170	48	48	28	25	90	106	81	95	16	14

Motor size	Poles	HB	L	LA	LB	LC	LD	M	N	O	P	S	T
280 SM ₋	2	465	1088	22	938	1238	332	500	450	100	550	18	5
	4-12	465	1088	22	938	1238	332	500	450	100	550	18	5
315 SM ₋	2	525	1218	25	1078	1367	351	600	550	115	660	23	6
	4-12	525	1248	25	1078	1397	381	600	550	115	660	23	6
315 ML ₋	2	525	1269	25	1129	1418	351	600	550	115	660	23	6
	4-12	525	1299	25	1199	1448	381	600	550	115	660	23	6
355 S ₋	2	600	1344	25	1204	1494	397	740	680	130	800	23	6
	4-12	600	1414	25	1204	1594	467	740	680	130	800	23	6

Tolerances:

D, DA ISO M6
F ISO h9
H +0, -1.0
N ISO j6 (280)
ISO js6 (315)

¹⁾ Cooling distance.
²⁾ Second shaft end on request.

Above table gives the main dimensions in mm.
For detailed drawings please see our web-pages
'www.abb.com/motors&drives' or contact us.

General purpose cast iron motors

Sizes 280-355

Dimension drawings

Foot- and flange-mounted; M B35 (IM 2001), IM V15 (IM 2011), IM V 36 (IM 2031)

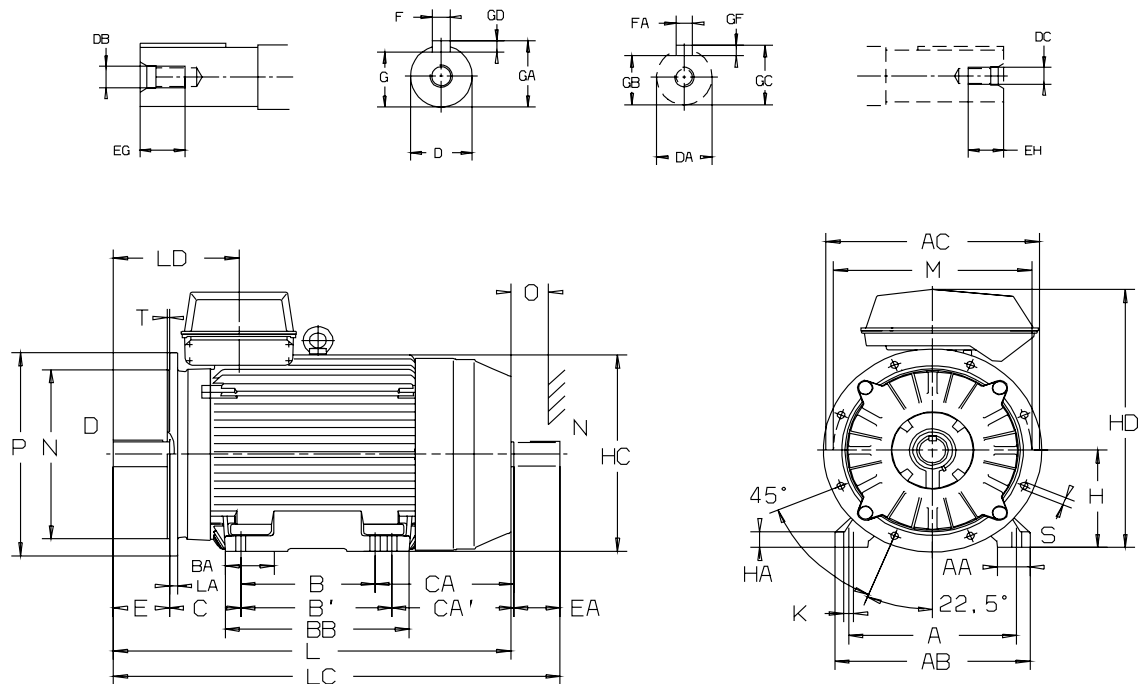

Motor size	Poles	A	AA	AB	AC	B	B'	BA	BB	C	CA	CA'	D	DA	DB	DC	E	EA	EG	EH	F	FA
280 SM	2	457	85	530	572	368	419	146	506	190	400	349	65	60	M20	M20	140	140	40	40	18	18
	4-12	457	85	530	572	368	419	146	506	190	400	349	75	65	M20	M20	140	140	40	40	20	18
315 SM	2	508	100	590	645	406	457	163	556	216	465	414	65	60	M20	M20	140	140	40	40	18	18
	4-12	508	100	590	645	406	457	163	556	216	465	414	80	75	M20	M20	170	140	40	40	22	20
315 ML	2	508	100	590	645	457	508	163	607	216	465	414	65	60	M20	M20	140	140	40	40	18	18
	4-12	508	100	590	645	457	508	163	607	216	465	414	90	75	M24	M20	170	140	48	40	25	20
355	2	610	120	700	740	500	-	161	662	254	460	-	70	70	M20	M20	140	140	40	40	20	20
	4-12	610	120	700	740	500	-	161	662	254	460	-	100	90	M24	M24	210	170	48	48	28	25

Motor size	Poles	G	GA	GB	GC	GD	GF	H	HA	HC	HD	K	L	LA	LC	LD	M	N	P	S	T	O ¹⁾
280 SM	2	58	69	53	64	11	11	280	40	566	745	24	1088	22	1238	332	500	450	550	18	5	100
	4-12	67.5	79.5	58	69	12	11	280	40	566	745	24	1088	22	1238	332	500	450	550	18	5	100
315 SM	2	58	69	53	64	11	11	315	50	638	840	30	1218	25	1367	351	600	550	660	23	6	115
	4-12	71	85	67.5	79.5	14	12	315	50	638	840	30	1248	25	1397	381	600	550	660	23	6	115
315 ML	2	58	69	53	64	11	11	315	50	638	840	30	1269	25	1418	351	600	550	660	23	6	115
	4-12	84	95	67.5	79.5	14	12	315	50	638	840	30	1299	25	1448	381	600	550	660	23	6	115
355 S	2	62.5	74.5	62.5	74.5	12	12	355	55	725	955	35	1344	25	1494	397	645	740	680	23	6	130
	4-12	90	106	81	95	16	14	355	55	725	955	35	1414	25	1594	467	715	740	680	23	6	130

Tolerances:

D, DA ISO M6
 F ISO h9
 H +0, -1.0
 N ISO j6 (280)
 ISO js6 (315)

¹⁾ Cooling distance.

²⁾ Second shaft end on request.

Above table gives the main dimensions in mm.

For detailed drawings please see our web-pages
 'www.abb.com/motors&drives' or contact us.

Rating plates

For motor sizes 71 to 132 the rating plate gives one current value for the voltage area. That is the highest current that can occur within the voltage area with the given output.

For motor sizes 160 to 355 the rating plate is in table form giving values for speed, current and power factor for six voltages.

Motor sizes 71 to 132

ABB		ABB Motors			CE	
3-motor M2QA 90 S2 A						IEC 34-1
3GQA091101-ASA						EFF2
6205/C3		6205/C3		IP 55		Ins.cl F
V	Hz	r/min	kW	cos φ	A	
220-240Δ	50	2850	1.5	0.87	5.58	
380-420Y	50	2850	1.5	0.87	3.23	
440-480Y	60	3420	1.73	0.87	3.30	
No 329 11117711				21 kg		

Motor sizes 160 to 250

ABB		ABB Motors			CE	
3 ~ motor M2QA 180 L4A						EFF2
IEC 180 L 48						
S1			No 292229936			
Cert.no		Ins.cl. F		IP 55		
V	Hz	kW	r/min	A	cos φ	tE/s
690 Y	50	22	1470	22.86	0.88	
400 Δ	50	22	1470	39.44	0.88	
660 Y	50	22	1465	23.37	0.90	
380 Δ	50	22	1465	40.59	0.90	
415 Δ	50	22	1475	38.90	0.86	
440 Δ	60	25.3	1764	40.06	0.89	
Cat. no 3GQA 182 501 - ADA						
6310/C3		6210/C3		186 kg		
IEC 34-1						

Motor sizes 280 to 355

CE		ABB Oy, Electrical Machines			LV Motors, Vaasa, Finland	
3~Motor M2BAT 315SMB 6 B6						
IEC 315 S/M 80						
S1		No. 0230-060100089				
Ins.cl. F		IP 55			Duty	
V	Hz	kW	r/min	A	cos φ	
690 Y	50	90	991	96	0.83	
400 D	50	90	991	166	0.83	
660 Y	50	90	990	100	0.84	
380 D	50	90	990	174	0.84	
415 D	50	90	992	163	0.81	
440 D	60	103	1190	170	0.84	
Prod.code 3GBA313220-ADD						
6319/C3		6316/C3		870 kg		
ABB		IEC 60034-1				

Motor construction

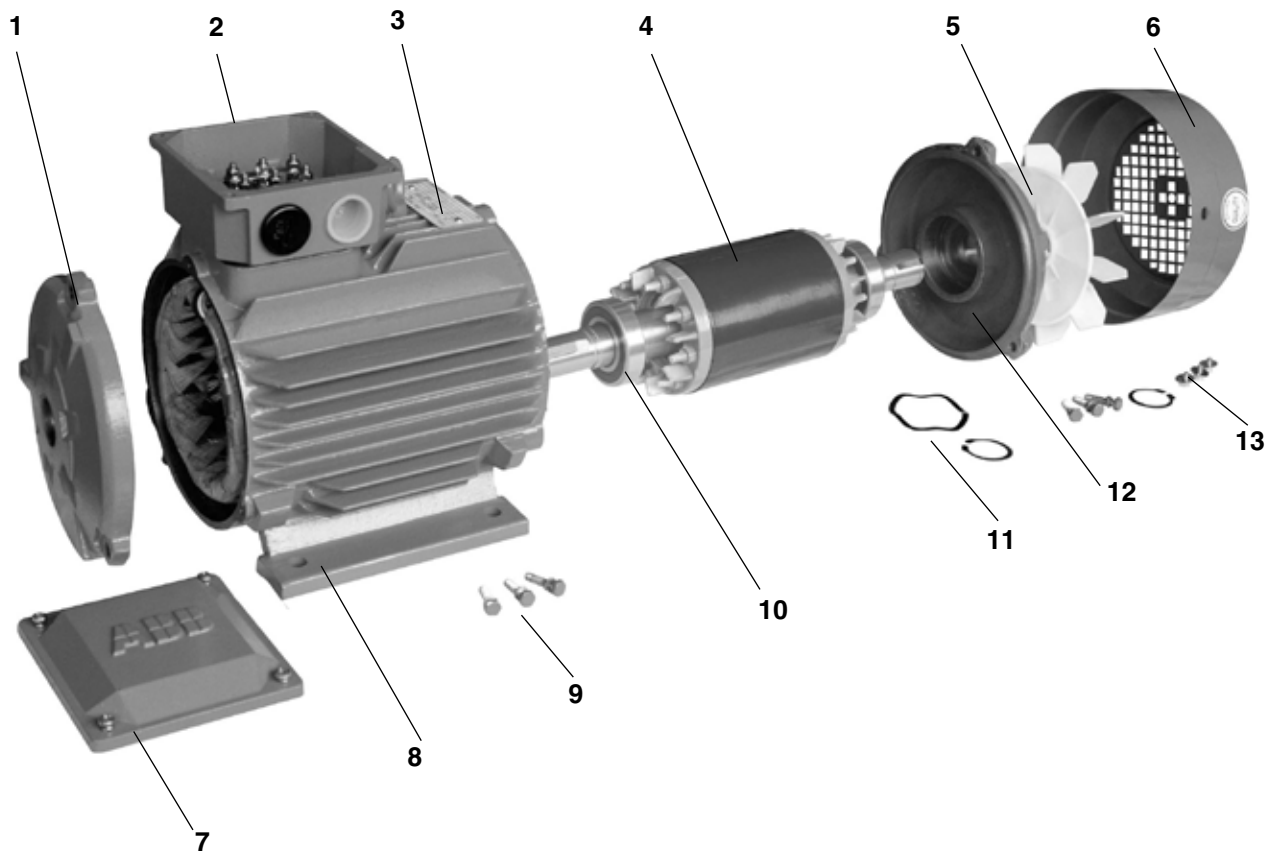

- | | | | |
|---|--------------------|----|------------------------|
| 1 | Endshield, D-end | 8 | Stator |
| 2 | Terminal box | 9 | Bolt |
| 3 | Rating plate | 10 | Bearing |
| 4 | Rotor | 11 | Wave-shape spring ring |
| 5 | Fan | 12 | Endshield, N-end |
| 6 | Fan cover | 13 | Screw |
| 7 | Terminal box cover | | |

General purpose cast iron motors in brief, basic design

Motor size		71	80	90	100	112	132	160
Stator	Material	Cast iron HT150 GB5675-85						
	Paint colour shade	Blue, Munsell 8B 4.5/3.25 / NCS 4822 B05G / RAL 5014						
	Paint thickness	Two-pack 821 Acid Polyurethane Lacquer Enamel, thickness ≥ 60 μ m						
Bearing end shields	Material	Cast iron HT150 GB5675-85						
	Paint colour shade	Blue, Munsell 8B 4.5/3.25 / NCS 4822 B05G / RAL 5014						
	Paint thickness	Two-pack 821 Acid Polyurethane Lacquer Enamel, thickness ≥ 60 μ m						
Bearings	D-end	6202 DDU C3	6204 DDU C3	6205 DDU C3	6206 DDU C3	6207 DDU C3	6208 DDUC3	6309 DDU C3
	N-end	6202 DDU C3	6204 DDU C3	6205 DDU C3	6206 DDU C3	6206 DDU C3	6207 DDU C3	6209 DDU C3
Axially-locked bearings	Inner bearing cover	As standard, locked at D-end						
Lubrication		Greased for life.						
Rating plate	Material	Stainless steel						
Terminal box	Frame material	Cast iron HT150 GB5675-85						
	Cover material	Cast iron HT150 GB5675-85						
Connections	Cable entries	2xM16x1.5	2xM25x1.5	2xM32x1.5	2xM32x1.5	2xM32x1.5	2xM32x1.5	2xM40x1.5
	Terminals	6 terminals for connection						
Fan	Material	Reinforced glass fiber						
Fan cover	Material	Steel						
	Paint colour shade	Blue, Munsell 8B 4.5/3.25 / NCS 4822 B05G / RAL 5014						
	Paint thickness	Two-pack 821 Acid Polyurethane Lacquer Enamel, thickness ≥ 60 μ m						
Stator winding	Material	Copper						
	Insulation	Insulation class F						
	Winding protection	On request						
Rotor winding	Material	Pressure die-cast aluminium						
Balancing method		Half key balancing as standard						
Key ways		Open key way						
Enclosure		IP 55						
Cooling method		IC 411						

General purpose cast iron motors in brief, basic design

Motor size		180	200	225	250	280	315	355	
Stator	Material	Cast iron HT150 GB5675-85				Cast iron GG 20/GRS 200			
	Paint colour shade	Blue, Munsell 8B 4.5/3.25 / NCS 4822 B05G / RAL 5014							
	Paint thickness	Two-pack 821 Acid Polyurethane Lacquer Enamel, thickness ≥ 60 μm				Two-pack epoxy paint, thickness ≥ 70 μm			
Bearing end shields	Material	Cast iron HT150 GB5675-85				Cast iron GG 20/GRS 200, except flange-mounted			
	Paint colour shade	Blue, Munsell 8B 4.5/3.25 / NCS 4822 B05G / RAL 5014							
	Paint thickness	Two-pack 821 Acid Polyurethane Lacquer Enamel, thickness ≥ 60 μm				Two-pack epoxy paint, thickness ≥ 70 μm			
Bearings	D-end 2 pole 4 to 8 pole	6310 DDU C3	6312 DDU C3	6313 ZZ C3	6314 C3	6316/C4 6316/C3	6316/C4 6319/C3	6316/C3 6322/C3	
	N-end 2 pole 4 to 8 pole	6210 DDU C3	6212 DDU C3	6213 ZZ C3	6214 C3	6316/C4 6316/C3	6316/C4 6316/C3	6316/C3 6319/C3	
Axially-locked bearings	Inner bearing cover	As standard, locked at D-end							
Lubrication		Greased for life or regreasable			Regreasable bearings				
Rating plate	Material	Stainless steel				Acid proof stainless steel			
Terminal box	Frame material	Cast iron HT150 GB5675-85				Cast iron GG 15/GRS 150			
	Cover material	Cast iron HT150 GB5675-85				Cast iron GG 15/GRS 150			
Connections	Cable entries	2xM40x1.5	2xM50x1.5	2xM50x1.5	2xM63x1.5	2xM63 + 2xM20			
	Terminals	6 terminals for connection							
Fan	Material	Reinforced glass fiber				Reinforced glass fiber or aluminium			
Fan cover	Material	Steel							
	Paint colour shade	Blue, Munsell 8B 4.5/3.25 / NCS 4822 B05G / RAL 5014							
	Paint thickness	Two-pack 821 Acid Polyurethane Lacquer Enamel, thickness ≥ 60 μm				Two-pack epoxy polyester paint, thickness ≥ 80 μm			
Stator winding	Material	Copper							
	Insulation	Insulation class F							
	Winding protection	3 PTC thermistors as standard, 150°C							
Rotor winding	Material	Pressure die-cast aluminium							
Balancing method		Half key balancing as standard							
Key way		Open key way							
Enclosure		IP 55				IP 55, higher protection on request			
Cooling method		IC 411							

ABB Motors' total product offer

ABB offers several comprehensive ranges of AC motors and generators. We manufacture synchronous motors for even the most demanding applications, and a full range of low and high voltage induction motors. Our in-depth knowledge of virtually every type of industrial processing ensures we always specify the best solution for your needs.



Low voltage motors and generators

General purpose motors for standard applications

- Aluminum motors
- Steel motors
- Cast iron motors
- Open drip proof motors
- Global motors
- Brake motors
- Single phase motors
- Integral motors

Process performance motors for more demanding applications

- Aluminum motors
- Cast iron motors
- Motors for high ambient temperatures

NEMA motors

High voltage and synchronous motors and generators

- High voltage cast iron motors
- Induction modular motors
- Slip ring motors
- Motors for hazardous areas
- Servomotors
- Synchronous motors and generators
- DC motors and generators

Motors for hazardous areas

- Flameproof motors
- Increased safety motors
- Non-sparking motors
- Dust ignition proof motors

Marine motors

- Aluminum motors
- Steel motors
- Cast iron motors
- Open drip proof motors

Other applications

- Permanent magnet motors
- High speed motors
- Wind turbine generators
- Smoke venting motors
- Water cooled motors
- Motors for roller table drives

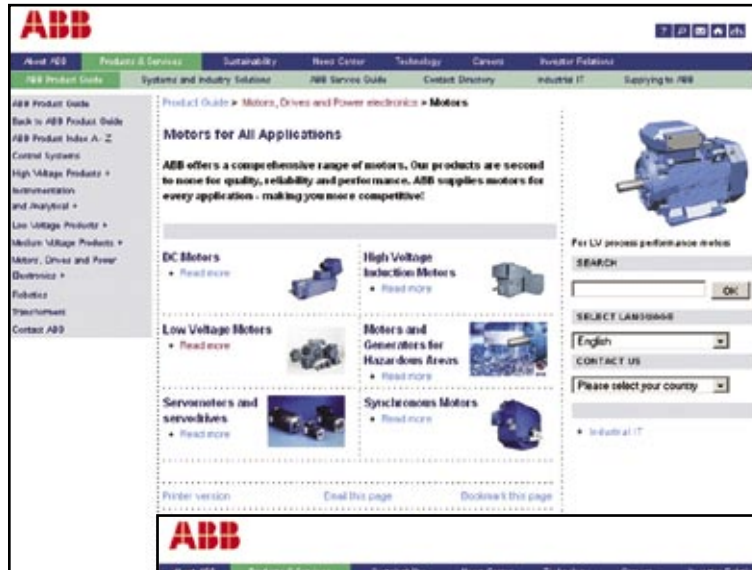

- Motors & Drives**
- => Low Voltage Motors
 - => **General purpose motors**
 - Aluminum motors
 - Steel motors
 - Cast iron motors
 - Global motors
 - Open drip proof motors
 - Brake motors
 - Single phase motors
 - Integral motors
 - Process performance motors
 - Motors for hazardous areas
 - Marine motors
 - Other applications
 - Roller table motors
 - Water cooled motors
 - Permanent magnet motors
 - High speed motors
 - Generators

Low Voltage Motors

Manufacturing sites (*) and some of the larger sales companies.

Australia

ABB Industry Pty Ltd
2 Douglas Street
Port Melbourne,
Victoria, 3207
Tel: +61 (0) 3 9644 4100
Fax: +61 (0) 3 9646 9362

Austria

ABB AG
Clemens Holzmeisterstrasse 11 B
AT-1810 Wien
Tel: +43 (0) 1 601 090
Fax: +43 (0) 1 601 09 8305

Belgium

Asea Brown Boveri S.A.-N.V.
Hoge Wei 27
BE -1930 Zaventem
Tel: +32 (0) 2 718 6311
Fax: +32 (0) 2 718 6657

Canada

ABB Inc., BA Electrical Machines
10300 Henri-Bourassa Blvd, West,
Saint-Laurent, Quebec
Canada H4S 1N6
Tel: +1 514 832-6583
Fax: +1 514 332-0609

China*

ABB Shanghai Motors
Company Limited
8 Guang Xing Rd., Rong Bei
Town, Songjiang County,
Shanghai 201613
Tel: +86 21 5778 0988
Fax: +86 21 5778 1364

Chile

Asea Brown Boveri S.A.
P.O.Box 581-3
Santiago
Tel: +56 (0) 2 5447 100
Fax: +56 (0) 2 5447 405

Denmark

ABB A/S
Automation Technology Electrical
Machines
Petersmindevej 1
DK-5000 Odense C
Tel: +45 65 477 070
Fax: +45 65 477 713

Finland*

ABB Oy
LV Motors
P.O.Box 633
FI-65101 Vaasa
Tel: +358 (0) 10 22 11
Fax: +358 (0) 10 22 47372

France

ABB Automation
Rue du Général de Gaulle
Champagne-sur-Seine
FR-77811 Moret-sur-Loing Cedex
Tel: +33 (0) 1 60 746 500
Fax: +33 (0) 1 60 746 565

Germany

ABB Automation Products GmbH
Edisonstrasse 15
DE-68623 Lampertheim
Tel: +49 (0) 6206 503 503
Fax: +49 (0) 6206 503 600

Hong Kong

ABB (Hong Kong) Ltd.
Tai Po Industrial Estate,
3 Dai Hei Street,
Tai Po, New Territories,
Hong Kong
Tel: +852 2929 3838
Fax: +852 2929 3505

India*

ABB Ltd.
32, Industrial Area, N.I.T
Faridabad 121 001
Tel: +91 (0) 129 502 3001
Fax: +91 (0) 129 502 3006

Indonesia

PT. ABB Sakti Industri
JL. Gajah Tunggal Km.1
Jatiuwung, Tangerang 15136
Banten, Indonesia
Tel: + 62 21 590 9955
Fax: + 62 21 590 0115 - 6

Ireland

Asea Brown Boveri Ltd
Components Division
Belgard Road
Tallaght, Dublin 24
Tel: +353 (0) 1 405 7300
Fax: +353 (0) 1 405 7327

Italy*

ABB SACE SpA
LV Motors
Via Della Meccanica, 22
IT-20040 Caponago - MI
Tel: +39 02 959 6671
Fax: +39 02 959 667216

Japan

ABB K.K.
26-1 Cerulean Tower
Sakuragaoka-cho, Shibuya-ku
Tokyo 150-8512
Tel: +81 (0) 3 578 46251
Fax: +81 (0) 3 578 46260

Korea

ABB Korea Ltd.
7-9fl, Oksan Bldg., 157-33
Sungshung-dong, Kangnam-ku
Seoul
Tel: +82 2 528 2329
Fax: +82 2 528 2338

Malaysia

ABB Malaysia Sdn. Bhd.
Lot 608, Jalan SS 13/1K
47500 Subang Jaya, Selangor
Tel: +60 3 5628 4888
Fax: +60 3 5631 2926

Mexico

ABB México, S.A. de C.V.
Apartado Postal 111
CP 54000 Tlalnepantla
Edo. de México, México
Tel: +52 5 328 1400
Fax: +52 5 390 3720

The Netherlands

ABB B.V.
Dept. LV motors (APP2R)
P.O.Box 301
NL-3000 AH Rotterdam
Tel: +31 (0) 10 4078 879
Fax: +31 (0) 10 4078 345

Norway

ABB AS
P.O.Box 154 Vollebakk
NO-0520 Oslo
Tel: +47 22 872 000
Fax: +47 22 872 541

Singapore

ABB Industry Pte Ltd
2 Ayer Rajah Crescent
Singapore 139935
Tel: +65 6776 5711
Fax: +65 6778 0222

Spain*

ABB Automation Products S.A.
Division Motores
P.O.Box 81
ES-08200 Sabadell
Tel: +34 93 728 8500
Fax: +34 93 728 8741

Sweden*

ABB Automation Technologies AB
LV Motors
SE-721 70 Västerås
Tel: +46 (0) 21 329 000
Fax: +46 (0) 21 329 140

Switzerland

ABB Schweiz AG
Normelec
Badenerstrasse 790
Postfach
CH-8048 Zürich
Tel: +41 (0) 58 586 0000
Fax: +41 (0) 58 586 0603

Taiwan

ABB Ltd.
6F, No. 126, Nanking East Road,
Section 4i
Taipei, 105 Taiwan, R.O.C.
Tel: +886 (0) 2 2577 6090
Fax: +886 (0) 2 2577 9467

Thailand

ABB Limited (Thailand)
161/1 SG Tower,
Soi Mahadlekluang 3,
Rajdamri, Bangkok 10330
Tel: +66 2 665 1000
Fax: +66 2 665 1042

The United Kingdom

ABB Automation Ltd
9 The Towers, Wilmslow Road
Didsbury
Manchester, M20 2AB
Tel: +44 (0) 161 445 5555
Fax: +44 (0) 161 448 1016

USA

ABB Inc.
Low Voltage Motors
16250 W. Glendale Drive
New Berlin, WI 53151
Tel: +1 262 785 3200
Fax: +1 262 785 8628

Venezuela

Asea Brown Boveri S.A.
P.O.Box 6649
Carmelitas,
Caracas 1010A
Tel: +58 (0) 2 238 2422
Fax: +58 (0) 2 239 6383



<http://www.abb.com/motors&drives>
<http://online.abb.com/motors&drives>